

RoHS Compliant

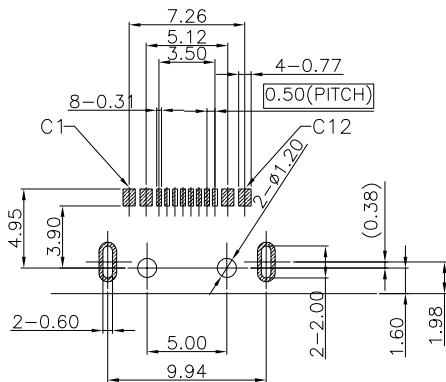

RECOMMENDED PCB LAYOUT(TOP VIEW)

THICKNESS T=1.0mm  
DEFAULT TOLERANCE+/-0.05

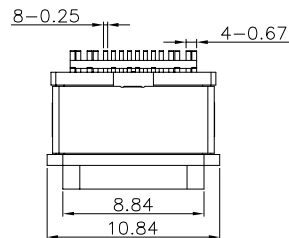
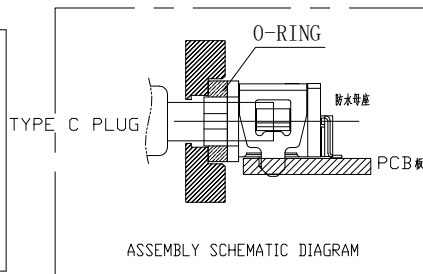
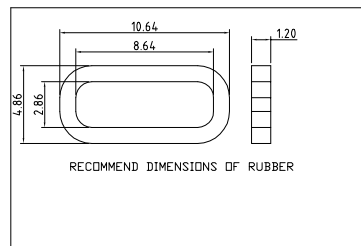
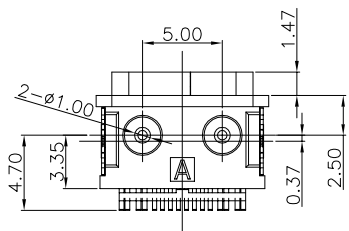
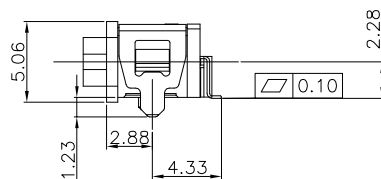
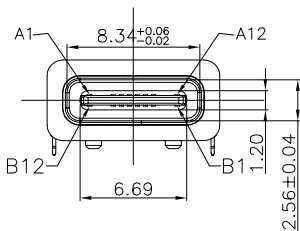

REVISIONS			
REV.	DESCRIPTION	DATE	DESIGN

NOTES:

- MATERIAL: SEE "TABLE 1";
- FINISH: SEE "TABLE 1";
- ELECTRICAL :
  - CONTACT CURRENT RATING :
    - 5A(VBUS PIN 1.5A/PIN),
    - 5A(GND PIN 1.25A/PIN MAX),0.25A/PIN(OTHER PIN).
  - INSULATION RESISTANCE :
    - 100 MEGAOHMS MIN. AT 250VDC.
  - DIELECTRIC WITHSTANDING VOLTAGE :
    - 100VAC MIN.
  - LOW LEVEL CONTACT RESISTANCE :
    - INITIAL 40mΩ MAX.
    - AFTER 50mΩ MAX.
- MECHANICAL CHARACTERISTICS :
  - MATING FORCE: 5~20N;
  - UNMATING FORCE: 8~20N(INITIAL),6~20N(AFTER 10000 CYCLES);
  - DURABILITY : 10,000 MATING CYCLES.
  - OPERATING TEMPERATURE :-40°C TO +80°C

INTERFACE(FRONT VIEW)

A1	A2	A3	A4	A5	A6	A7	A8	A9	A10	A11	A12
GND		VBUS	CC1	DP1	DN1	SBU1	VBUS				GND
GND		VBUS	SBU2	DN2	DP2	CC2	VBUS				GND
B12	B11	B10	B9	B8	B7	B6	B5	B4	B3	B2	B1

PIN ASSIGNMENT

PIN NO.	A1&B12	A4&B9	B8	A5	B7	A6	A7	B6	A8	B5	A9&B4	A12&B1
SIGNAL NAME	GND	VBUS	SBU2	CC1	DN2	DP1	DN1	DP2	SBU1	CC2	VBUS	GND
PCB PAD NO.	C1	C2	C3	C4	C5	C6	C7	C8	C9	C10	C11	C12

PART NO. INFORMATION

U06-C F X X 5 R - W074

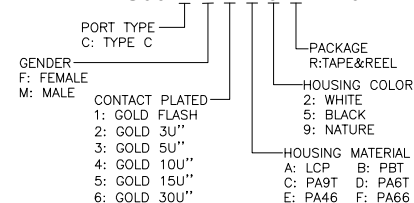

TABLE 1:

NO.	PART NAME	QTY	MATERIAL	DESCRIPTION	REMARK
⑥	Shell-2	1	SUS304	NI PLATING;	T=0.20mm
⑤	Shell-1	1	SUS304	NI PLATING;	T=0.25mm
④	MID PLATE	1	SUS304		T=0.15mm
③	Terminal-B	8	High Conductivity Copper C7025	Au:3u" PLATING;	T=0.15mm
②	Terminal-A	8		Au:3u" PLATING;	T=0.15mm
①	Housing	1	PA46	Black	

**Bestcreate Technology Limited**

TOLERANCES UNLESS OTHERWISE SPECIFIED:

.X	± 0.30	X.'	± 2'
.XX	± 0.10	.X'	± 1'
.XXX	± 0.05	.XX'	± 0.5'

Website:www.bsc-elec.com  
Email:bestcreate@bsc-elec.com

DESIGN: I.L DATE:

CHECKED: C.W DATE:

APPROVED: C.W DATE:

TITLE: IPX8 Waterproof 16P USB C Female Connector SMT Type

MATERIAL: PART NO: U06-CFXX5R-W074 SIZE: A4  
FINSH: DWG NO: U06-CFXX5R-W074

REV: A UNIT mm SCALE 1=1 QUALITY SYMBOLS