

RoHS Compliant

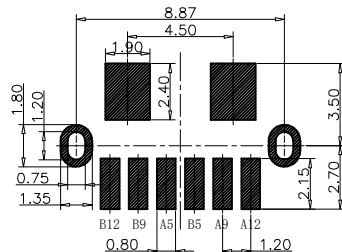

RECOMMEND P.C.B LAYOUT (COMPONENT SIDE)  
TOLERANCE FOR PCB LAYOUT IS ±0.05

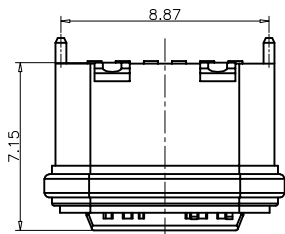
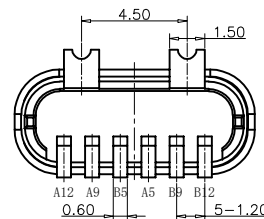
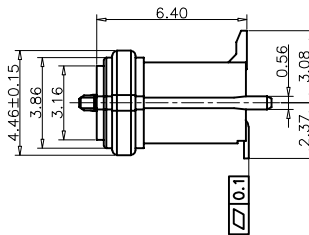
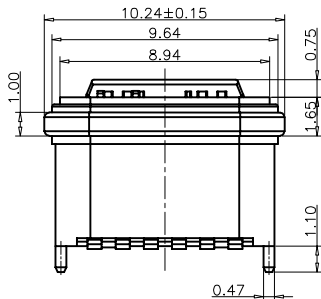
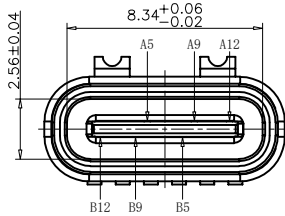

TABLE:

NO	PART	Q'TY	Material
1	SHELL	1	ZINC ALLOY, NI PLATED
2	CONTACT	6	COPPER STEEL, TIN/AU/NI PLATED
3	1MD HOUSING	1	HIGH TEMPERATURE RESISTANT PLASTIC BLACK UL94 V-0
4	WATERPROOF RING	1	SILICONE UL94 V-0 BLACK

REVISIONS

REV.	DESCRIPTION	DATE	DESIGN

NOTES:

- SPECIFICATION:
- CURRENT RATING: 3.0 A
  - VOLTAGE RATING: 5.0 V
  - VBUS & GND PINS AND OTHER PINS: 40mΩ/PIN MAX  
SHIELD: 50mΩ/MAX  
LLCR MAX. CHANGE OF ALL PINS: 100m
  - INSULATION RESISTANCE: 100MΩ MIN
  - DIELECTRIC WITHSTAND VOLTAGE, AC 100V FOR 1MINUTE
  - INSERTION FORCE: 0.5~2.0kgf
  - UNMATING FORCE: 0.6-2.04kgf
  - DURABILITY: 10000 CYCLES
  - OPERATING TEMPERATURE: -20°C~+85°C
  - THE PEAK TEMPERATURE ON THE BOARD SHALL BE MAINTAINED FOR 10 SECONDS AT 210-230°C
  - WATERPROOF: IP-X7.

PART NO. INFORMATION

U06-C F X X 5 R - W002 - V1

- PORT TYPE  
C: TYPE C
- GENDER  
F: FEMALE  
M: MALE
- CONTACT PLATED  
1: GOLD FLASH  
2: GOLD 3U"  
3: GOLD 5U"  
4: GOLD 10U"  
5: GOLD 15U"  
6: GOLD 30U"
- HOUSING MATERIAL  
A: LCP B: PBT  
C: PA9T D: PA6T  
E: PA46 F: PA66
- PACKAGE  
R: TAPE REEL
- HOUSING COLOR  
2: WHITE  
5: BLACK  
9: NATURE

USB TYPE C PIN ASSIGNMENTS

PIN NUMBER	SIGNAL NAME	PIN NUMBER	SIGNAL NAME
		B12	GND
		B9	VBUS
A5	CC1		
		B5	CC2
A9	VBUS		
A12	GND		

**Bestcreate Technology Limited**

TOLERANCES UNLESS OTHERWISE SPECIFIED:

X.	± 0.15	X'	± 10'
.X	± 0.10	.X'	± 8'
.XX	± 0.05	.XX'	± 5'

DESIGN: I. L DATE:

CHECKED: C. W DATE:

APPROVED: C. W DATE:

TITLE:  
IP67 WATERPROOF 6P USB C FEMALE CONNECTOR VERTICAL  
SMT, L=7.15MM

MATERIAL:	PART NO: U06-CFXX5R-W002-V1	SIZE: A4
FINISH:	DWG NO: U06-CFXX5R-W002-V1	1 OF 3

REV: A	UNIT mm	SCALE 1=1	QUALITY SYMBOLS
--------	---------	-----------	-----------------

Website: www.bsc-elec.com  
Email: bestcreate@bsc-elec.com

1

2

3

4

5

6

7

8

RoHS Compliant



REVISIONS			
REV.	DESCRIPTION	DATE	DESIGN

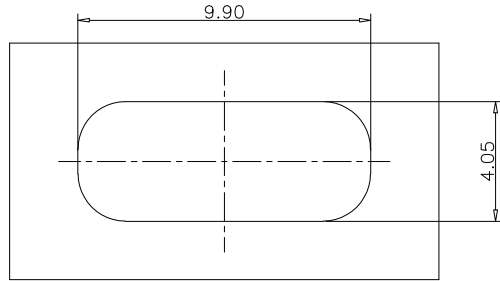

密封开孔参考尺寸(只供参考)  
 组装外壳时需要打环保润滑油

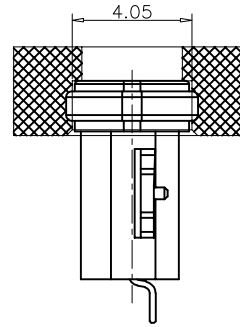
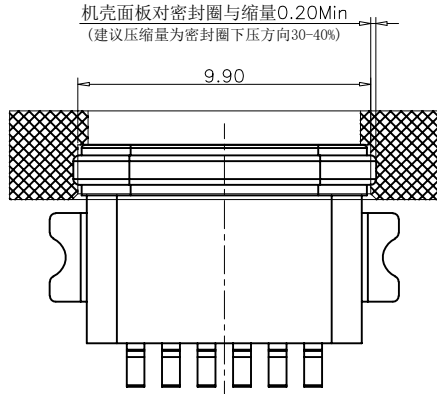

**Bestcreate Technology Limited**

TOLERANCES UNLESS OTHERWISE SPECIFIED:

X.	± 0.15	X.*	± 10°
.X	± 0.10	.X*	± 8°
.XX	± 0.05	.XX*	± 5°

Website: [www.bsc-elec.com](http://www.bsc-elec.com)  
 Email: [bestcreate@bsc-elec.com](mailto:bestcreate@bsc-elec.com)

DESIGN: I. L      DATE:      TITLE:

CHECKED: C. W      DATE:      IP67 WATERPROOF 6P USB C FEMALE CONNECTOR VERTICAL SMT, L=7.15MM

APPROVED: C. W      DATE:      FINISH:      PART NO: U06-CFXX5R-W002-V1      SIZE: A4

DWG NO: U06-CFXX5R-W002-V1      2 OF 3

REV: A      UNIT: mm      SCALE: 1=1      QUALITY SYMBOLS:

RoHS Compliant

REVISIONS			
REV.	DESCRIPTION	DATE	DESIGN

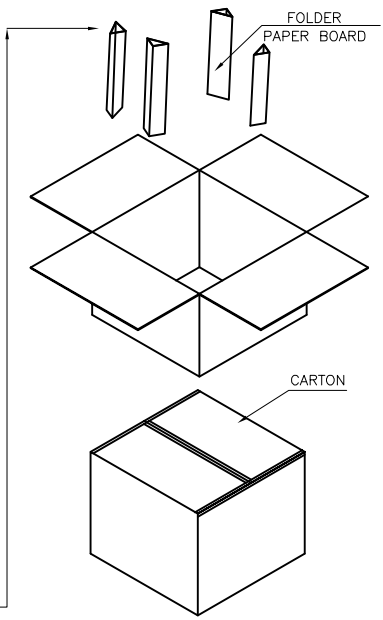
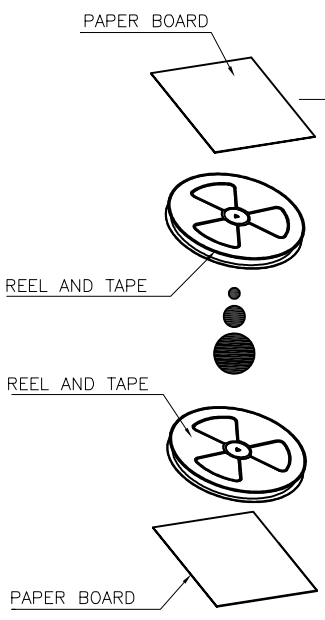
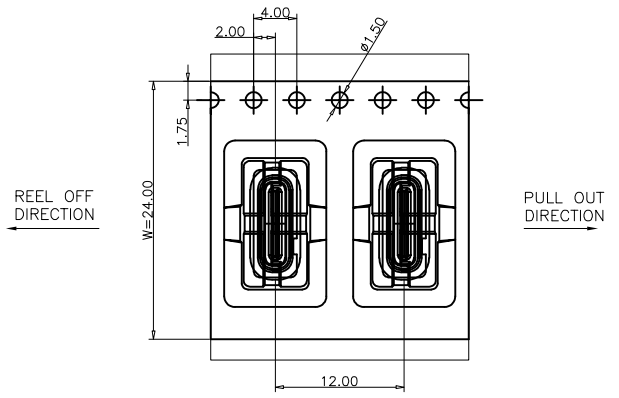
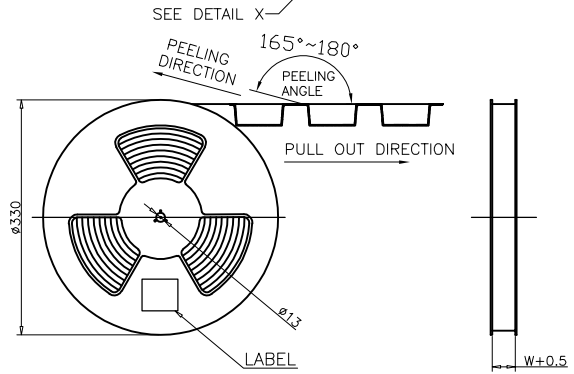
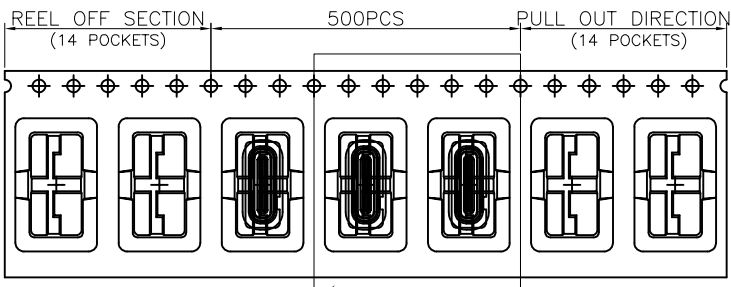

	REEL	CARTON
CONNECTOR (PCS)	500	5000

**Bestcreate Technology Limited**

TOLERANCES UNLESS OTHERWISE SPECIFIED:		DESIGN: I. L	DATE:
X. ± 0.15	X.' ± 10'	CHECKED: C. W	DATE:
.X ± 0.10	.X' ± 8'	APPROVED: C. W	DATE:
.XX ± 0.05	.XX' ± 5'	Website: www.bsc-elec.com	
Email: bestcreate@bsc-elec.com			

TITLE: IP67 WATERPROOF 6P USB C FEMALE CONNECTOR VERTICAL SMT, L=7.15MM			
MATERILA:	PART NO: U06-CFXX5R-W002-V1	SIZE: A4	
FINSH:	DWG NO: U06-CFXX5R-W002-V1	3 OF 3	

REV: A	UNIT mm	SCALE 1=1	QUALITY SYMBOLS
--------	---------	-----------	-----------------