

RoHS Compliant

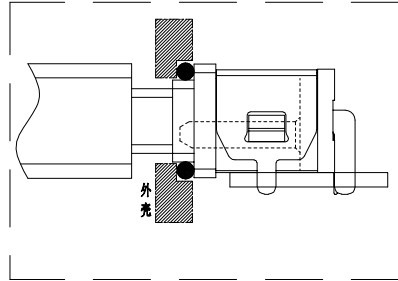
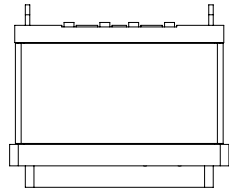

REVISIONS			
REV.	DESCRIPTION	DATE	DESIGN

NOTES:

SPECIFICATION:

1. CURRENT RATING: 3.0A MAX
2. DIELECTRIC WITHSTAND VOLTAGE: 100VAC
3. TEMPERATURE RANGE: -30 °C ~ 85 °C
4. CONTACT RESISTANCE: 40 MILLIONHM MAX
5. INSULATION RESISTANCE: 100 MEGOHMS MIN.
6. INSERTION FORCE :8N~35N
7. UNMATING FORCE: 8N~35N
8. DURABILITY:1500 CYCLES

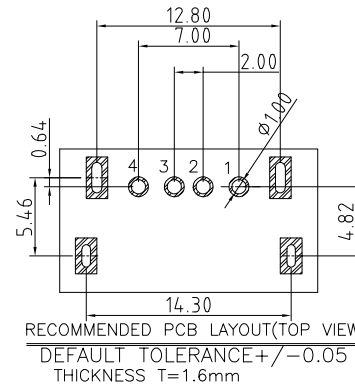
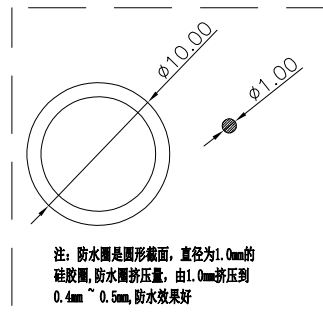
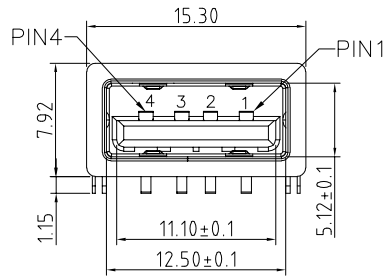

PART NO. INFORMATION

U01-A F X X 5 R - W007

- PORT TYPE
B: TYPE A
- GENDER
F: FEMALE
M: MALE
- CONTACT PLATED
1: GOLD FLASH
2: GOLD 3U"
3: GOLD 5U"
4: GOLD 10U"
5: GOLD 15U"
6: GOLD 30U"
- PACKAGE
R: TAPE REEL T: TRAY
- HOUSING COLOR
2: WHITE
5: BLACK
9: NATURE
- HOUSING MATERIAL
A: LCP B: PBT
C: PA9T D: PA6T
E: PA46 F: PA66
G: PA10T

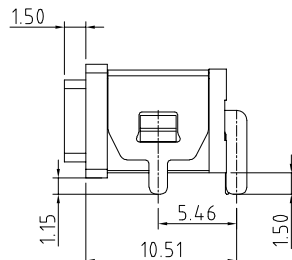
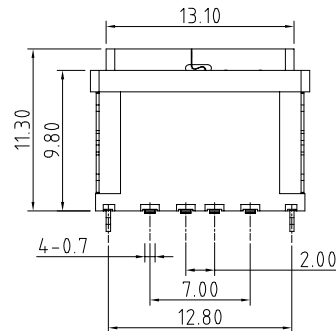

PIN ASSIGNMENT

PIN NO.	1	2	3	4
SINGAL NAME	VBUS	D-	D+	GND

ITEM	PART NAME	Q'TY	FINISH	NOTE
3	Shell	1	SUS 301 1/4H Ni Plating	Ni: 40~120U"
3	PLASTIC Shell	1	PA10T (G.F30%)	BLACK UL94-V0
2	Contact	4	BRASS C2680-EH Au/Ni/FoggingTin Plating T=0.25mm	Ni40-160u", AuContact Area3U", Other AreaFoggin Tin.
1	Housing	1	PA10T (G.F30%)	BLACK UL94-V0

Bestcreate Technology Limited

TOLERANCES UNLESS OTHERWISE SPECIFIED:

X.	± 0.50	X.'	± 2'
.X	± 0.30	.X'	± 1'
.XX	± 0.10	.XX'	± 0.5'

Website: www.bsc-elec.com

Email: bestcreate@bsc-elec.com

DESIGN:

DATE:

I.L

2017. 3. 1

CHECKED:

DATE:

C.W

2017. 3. 1

APPROVED:

DATE:

C.W

2017. 3. 1

TITLE:

IPX8 WATERPROOF USB 2.0 A FEMALE CONNECTOR

MATERILA:

PART NO:

U01-AFXX5R-W007

SIZE:

A4

FINSH:

DWG NO:

U01-AFXX5R-W007

REV:

A

1

UNIT

mm

SCALE

1=1

2

QUALITY SYMBOLS

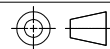

3

4

5

6

7

8