

RoHS Compliant

REVISIONS			
REV.	DESCRIPTION	DATE	DESIGN

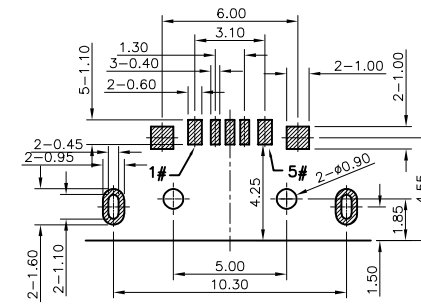

RECOMMENDED P.C.B. LAYOUT (TOP VIEW)  
GENERAL TOLERANCE: ±0.05

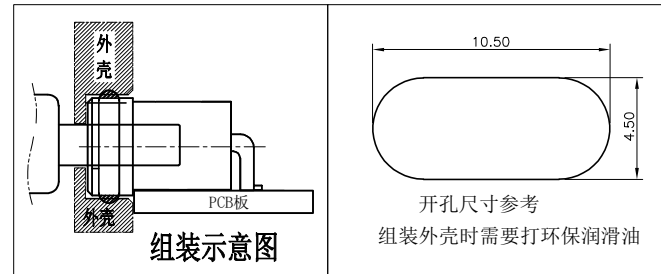
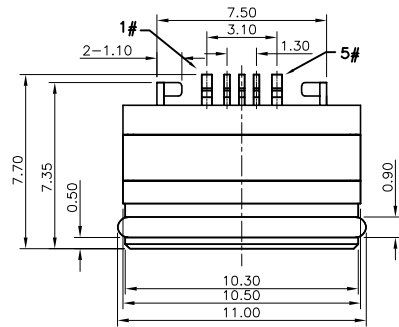
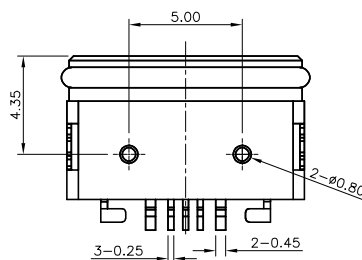
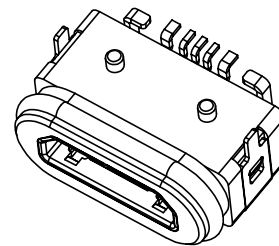
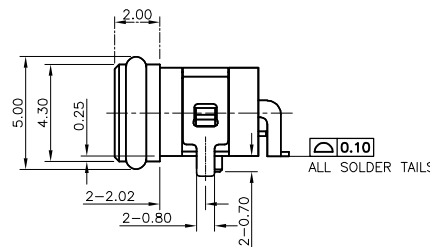
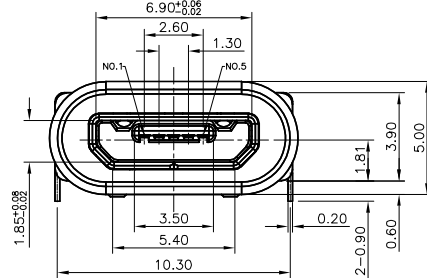

Contact Number	Signal Name	Remarks
1#	VBUS	Power
2#	D-	Date-
3#	D+	Date+
4#	ID	Reserve or Gound
5#	GND	Gound

NO.	DESCRIPTION	QTY	MATERIAL	REMARK
①	Oval ring	1	Rubber	Black
②	Glue	1	-----	Black
③	U-shaped frame	1	Copper alloy or stainless	Nickel plated
④	Inner shell	1	Copper alloy or stainless	Nickel plated
⑤	Terminal	5	Copper alloy, 0.15t	Gold Plated on Contact Area
⑥	Outer shell	1	High temperature thermoplastic	Black
⑦	Body	1	High temperature thermoplastic	Black

SPECIFICATIONS:

- ELECTRICAL CHARACTERISTICS:
  - RATING: 3A(PIN1&5),0.5A(PIN2&3&4);
  - CONTACT RESISTANCE: 30 mΩ MAX.(INITIAL);
  - DIELECTRIC WITHSTANDING: 500V AC MIN.;
  - INSULATION RESISTANCE: 1000MΩ MIN.;
- DURABILITY: 10,000 CYCLES MIN.;
- INSERTION FORCE: 3.5Kgf (35N) Max.;
- EXTRACTION FORCE: 0.8Kgf (8N) Min.;
- WATER PROOFNESS: THIS PRODUCT IS BASED ON IPX8.
- PLUG INTERFACE DIMENSIONS CONFORM TO USB2.0 SPEC.
- PACKAGING: TAPE & REEL.

PART NO. INFORMATION

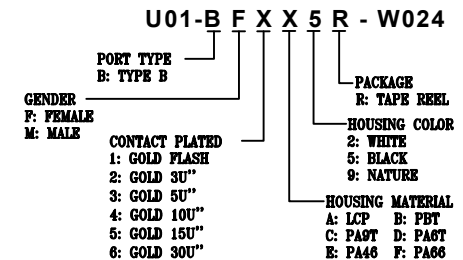

**Bestcreate Technology Limited**

TOLERANCES UNLESS OTHERWISE SPECIFIED:

X.	± 0.20	X.*	± 2'
.X	± 0.15	.X*	± 1'
.XX	± 0.10	.XX*	± 0.5'

DESIGN: I.L  
DATE: 2017/3/1

CHECKED: C.W  
DATE: 2017/3/1

APPROVED: C.W  
DATE: 2017/3/1

TITLE: IPX8 WATERPROOF MICRO USB 2.0 5P B FEMALE CONNECTOR WITH SCREW

MATERILA: FINSH: PART NO: U01-BFXX5R-W024 SIZE: A4

DWG NO: U01-BFXX5R-W024 SHEET: 1 OF 1

REV: A UNIT mm SCALE 1=1 QUALITY SYMBOLS

Website: [www.bsc-elec.com](http://www.bsc-elec.com)  
E-mail: [bestcreate@bsc-elec.com](mailto:bestcreate@bsc-elec.com)