

RoHS Compliant

REVISIONS			
REV.	DESCRIPTION	DATE	DESIGN

备注:

1. 产品规格:

- 1-1. 插入力: 35N MAX.
- 1-2. 拔出力: 10N MIN. INITIAL 8-20N AFTER
- 1-3. 额定电流: 1.5A
- 1-4. 额定电压: 30V
- 1-5. 耐久性: 10000 CYCLES MIN.
- 1-6. 耐电压: 100V AC MIN.
- 1-7. 接触阻抗: 30mΩ MAX. INITIAL; 40mΩ MAX AFTER

- 1-8. 绝缘电阻: 1000MΩ MIN
- 1-9. 工作温度: -30° TO +80°

2. 材质:

- 2.1 胶芯: LCP UL94V-0
  - 2.2 端子: C2680R-H, 镍底, 镀金1μ"
  - 2.3 外壳: SUS201/301, 表面镀雾锡/镀镍
3. 重点尺寸标识"▲"符号

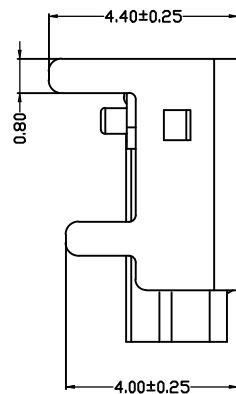
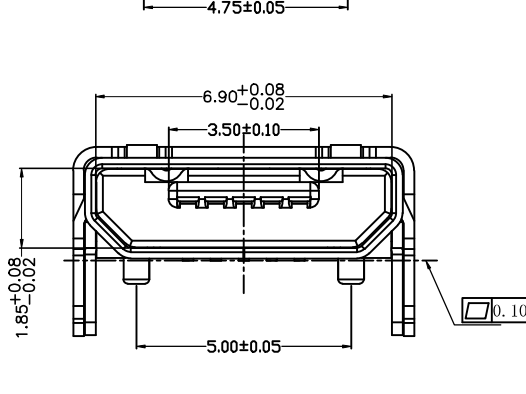
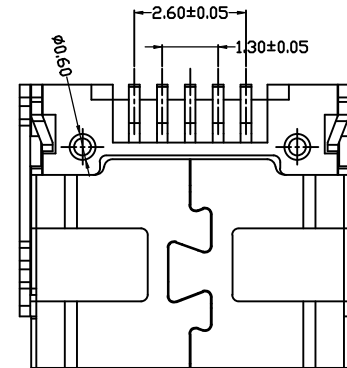
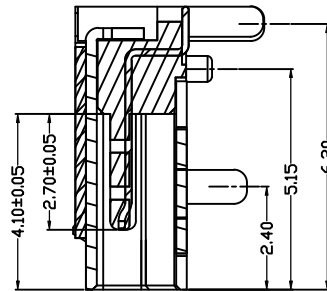
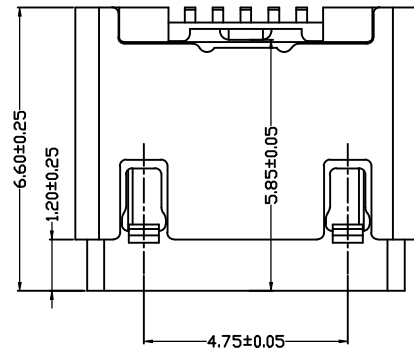
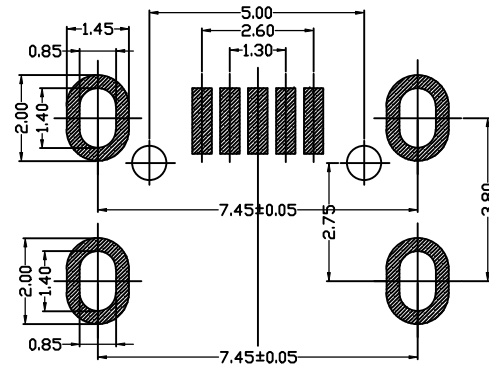
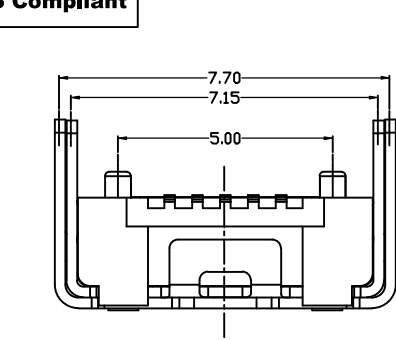

PART NO. INFORMATION

**U01-B F X X 5 R - 805**

PORT TYPE A: TYPE A	PACKAGE R: TAPE REEL
GENDER F: FEMALE M: MALE	HOUSING COLOR 2: WHITE 5: BLACK 9: NATURE
CONTACT PLATED 1: GOLD FLASH 2: GOLD 3U" 3: GOLD 5U" 4: GOLD 10U" 5: GOLD 15U" 6: GOLD 30U"	HOUSING MATERIAL A: LCP B: PBT C: PA9T D: PA6T E: PA46 F: PA66

**Bestcreate Technology Limited**

TOLERANCES UNLESS OTHERWISE SPECIFIED:

X.	± 0.30	X.*	± 3'
.X	± 0.20	.X*	± 2'
.XX	± 0.10	.XX*	± 1'

Website: [www.bsc-elec.com](http://www.bsc-elec.com)  
E-mail: [bestcreate@bsc-elec.com](mailto:bestcreate@bsc-elec.com)

DESIGN: I. L DATE: 2017/3/1

CHECKED: C. W DATE: 2017/3/1

APPROVED: C. W DATE: 2017/3/1

TITLE: MICRO USB 5P A FEMALE CONNECTOR

MATERILA:	PART NO: U01-BFXX5R-805	SIZE: A4
FINSH:	DWG NO: U01-BFXX5R-805	SHEET: 1 OF 1

REV: A	UNIT mm	SCALE 1=1	QUALITY SYMBOLS
--------	---------	-----------	-----------------