

RoHS Compliant

REVISIONS			
REV.	DESCRIPTION	DATE	DESIGN

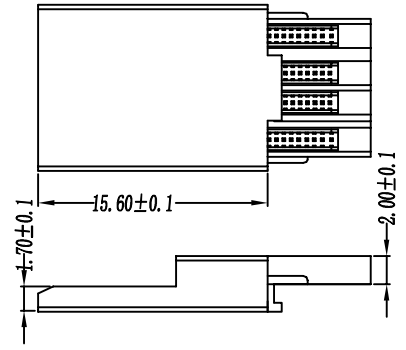
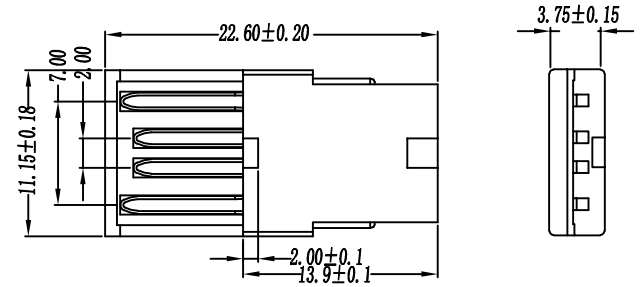
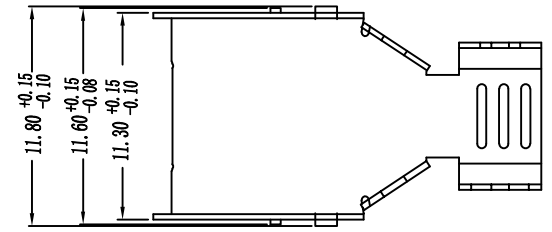
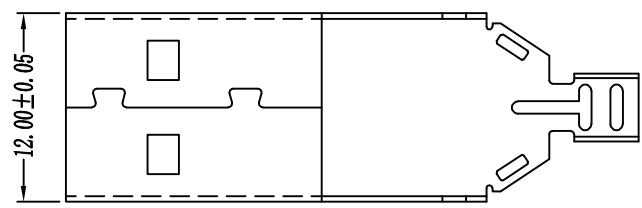
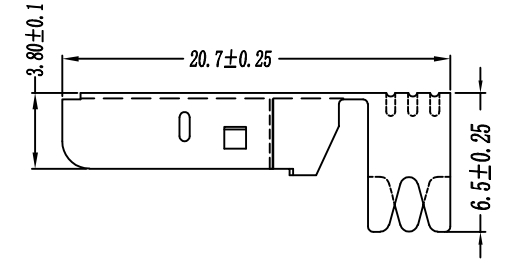
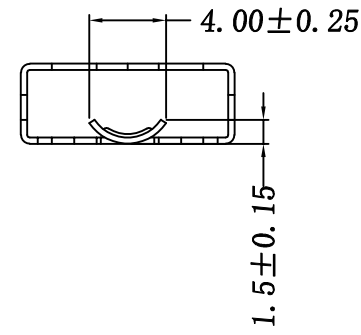
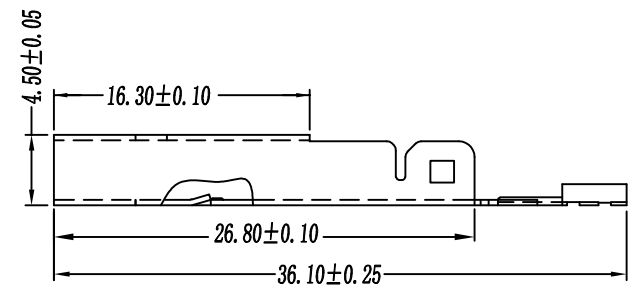

备注:

- 材质:
外壳:SPCC T=0.30;端子:C2680 T=0.20;胶芯 PBT(黑、白)
- 电镀:
外壳:镀全NI, 盐雾测试24H; 端子:GF

PART NO. INFORMATION

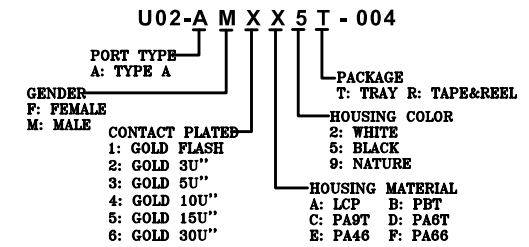

Bestcreate Technology Limited

TOLERANCES UNLESS OTHERWISE SPECIFIED:	
X. ± 0.38	X.' ± 3'
.X ± 0.30	.X' ± 2'
.XX ± 0.25	.XX' ± 1'
Website:www.bsc-elec.com	
Email:bestcreate@bsc-elec.com	

DESIGN:	DATE:
I.L	2017.3.1
CHECKED:	DATE:
C.W	2017.3.1
APPROVED:	DATE:
C.W	2017.3.1

TITLE: USB 2.0 A/M WIRE SOLDERING 3 IN 1		
MATERILA:	PART NO: U02-AMXX5T-004	SIZE: A4
FINSH:	DWG NO: U02-AMXX5T-004	

REV: A	UNIT mm	SCALE 1=1	QUALITY SYMBOLS
--------	---------	-----------	-----------------