

RoHS Compliant

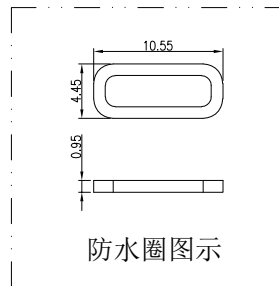
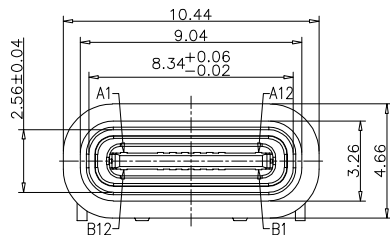
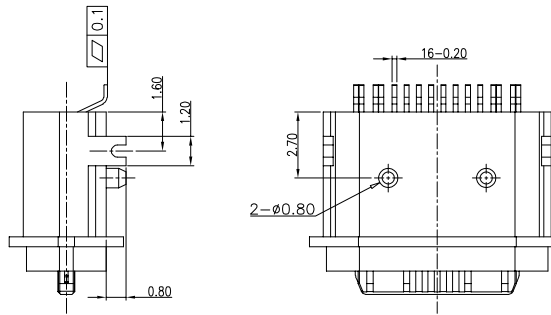
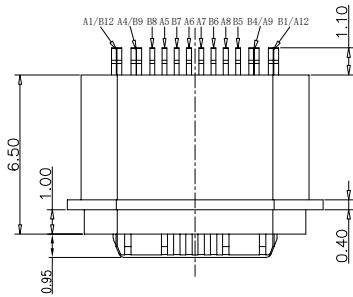
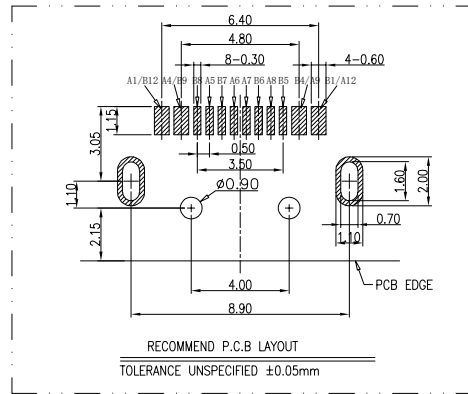
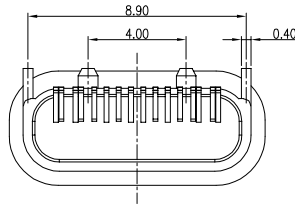
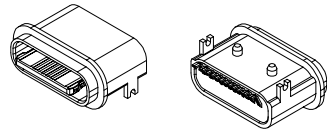

REVISIONS

REV.	DESCRIPTION	DATE	DESIGN

NOTES:

SPECIFICATION:

- CURRENT RATING: 3.0 A
- VOLTAGE RATING: 3.0 V
- VBUS & GND PINS AND OTHER PINS: 40mΩ/PIN MAX
SHIELD: 50mΩ/MAX
LLCR MAX. CHANGE OF ALL PINS: 100m
- INSULATION RESISTANCE: 100MΩ MIN
- DIELECTRIC WITHSTAND VOLTAGE, AC 100V FOR 1MINUTE
- INSERTION FORCE: 0.5-2.0kgf
- UNMATING FORCE: 0.8-2.0kgf
- DURABILITY: 10000 CYCLES
- OPERATING TEMPERATURE: -35°C~+85°C
- THE PEAK TEMPERATURE ON THE BOARD SHALL BE MAINTAINED FOR 10 SECONDS AT 260°C
- WATERPROOF: IP-X7.

USB TYPE C PIN ASSIGNMENTS

PIN NUMBER	SIGNAL NAME	PIN NUMBER	SIGNAL NAME
A1	GND	B12	GND
A4	VBUS	B9	VBUS
A5	CC1	B8	SBU2
A6	DP1	B7	DN2
A7	DN1	B6	DP2
A8	SBU1	B5	CC2
A9	VBUS	B4	VBUS
A12	GND	B1	GND

TABLE:

NO	PART	Q'TY	Material
1	SHELL	1	ZINC ALLOG, NI30u"Min PLATED
2	CONTACT	16	C7025, TIN80u"/Au3u"/Ni30u"PLATED
3	MID PLATE	1	SUS301, NO PLATING
4	HOUSING	1	LCP(E130i) UL94 V-0 BLACK
5	WATERPROOF RING	1	SILICONE(SI/60-65A) UL94 V-0 BLACK

PART NO. INFORMATION

U06-C F X X 5 R - W027

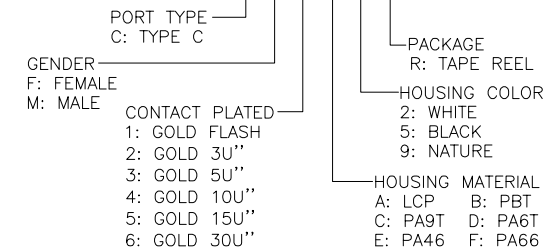

Bestcreate Technology Limited

TOLERANCES UNLESS OTHERWISE SPECIFIED:

.X	± 0.20	.X'	± 5'
.XX	± 0.15	.X''	± 2'
.XXX	± 0.10	.X'''	± 1'

Website: www.bsc-elec.com

Email: bestcreate@bsc-elec.com

DESIGN: I. L DATE:

CHECKED: C. W DATE:

APPROVED: C. W DATE:

TITLE:

IPX7 Waterproof USB TYPE C 16P FEMALE CONNECTOR
Top Mount type, L=6.50mm

MATERIAL:	PART NO:	SIZE:
	U06-CFXX5R-W027	A4
FINISH:	DWG NO:	
	U06-CFXX5R-W027	

REV:	UNIT	SCALE	QUALITY SYMBOLS
A	mm	1=1	