

RoHS Compliant

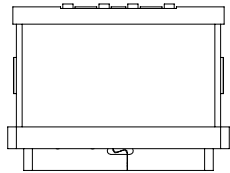

规格书

1. 额定电流: 3.0A
2. 耐电压: 500VAC
3. 工作温度范围: -30 °C ~ 85 °C
4. 接触电阻: 接触电阻 ≤ 30mΩ
5. 绝缘电阻: 绝缘电阻 ≥ 1000MΩ
6. 插入力: 8N~35N
7. 拔出力: 8N~35N
8. 插拔耐久: 1500 CYCLES

REVISIONS			
REV.	DESCRIPTION	DATE	DESIGN

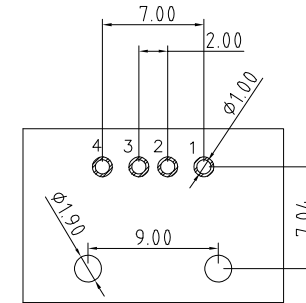

RECOMMENDED PCB LAYOUT(TOP VIEW)  
 DEFAULT TOLERANCE+/-0.05  
 THICKNESS T=1.0mm

PIN ASSIGNMENT

PIN NO.	1	2	3	4
SIGNAL NAME	GND	D+	D-	VBUS

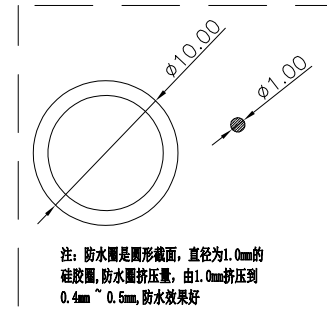
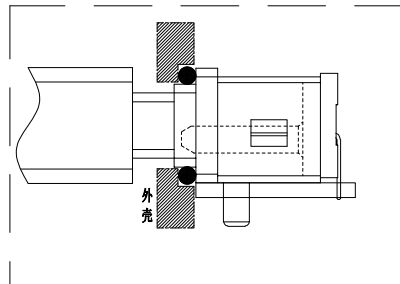
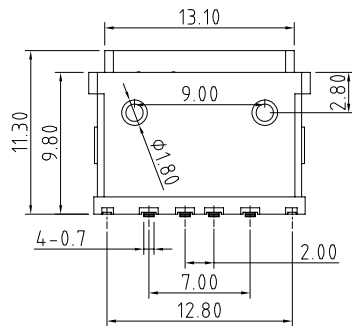
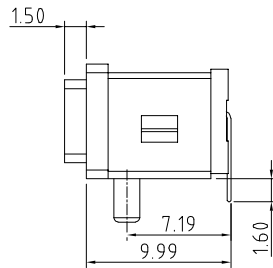
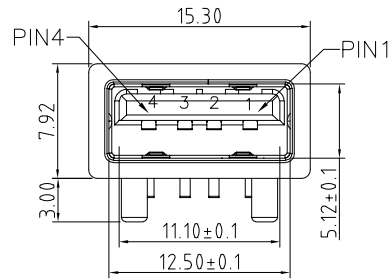

注: 防水圈是圆形截面, 直径为1.0mm的硅胶圈, 防水圈挤压力, 由1.0mm挤压力到0.4mm~0.5mm, 防水效果好

PART NO. INFORMATION

**U01-A F X X 5 R - W008**

PORT TYPE  
 B: TYPE A

GENDER  
 F: FEMALE  
 M: MALE

CONTACT PLATED  
 1: GOLD FLASH  
 2: GOLD 3U"  
 3: GOLD 5U"  
 4: GOLD 10U"  
 5: GOLD 15U"  
 6: GOLD 30U"

PACKAGE  
 R: TAPE REEL T: TRAY

HOUSING COLOR  
 2: WHITE  
 5: BLACK  
 9: NATURE

HOUSING MATERIAL  
 A: LCP B: PBT  
 C: PA9T D: PA6T  
 E: PA46 F: PA66  
 G: PA10T

ITEM	PART NAME	Q'TY	FINISH	NOTE
3	Shell	1	SUS 301 1/4H	
3	PLASTIC Shell	1	PA9T&LCP (G.F30%)	
2	Contact	4	BRASS C2680-EH Au/Ni Plating T=0.25mm	
1	Housing	1	PA10T (G.F30%)	

**Bestcreate Technology Limited**

REV: A UNIT mm SCALE 1=1 QUALITY SYMBOLS

TOLERANCES UNLESS OTHERWISE SPECIFIED:

X.	±	0.50	X.'	±	2'
.X	±	0.30	.X'	±	1'
.XX	±	0.10	.XX'	±	0.5'

Website: www.bsc-elec.com  
 Email: bestcreate@bsc-elec.com

DESIGN: I.L DATE: 2017.3.1  
 CHECKED: C.W DATE: 2017.3.1  
 APPROVED: C.W DATE: 2017.3.1

TITLE: IPX8 WATERPROOF TOP MOUNT USB 2.0 A FEMALE CONNECTOR

MATERILA:	PART NO: U01-AFXX5R-W008	SIZE: A4
FINSH:	DWG NO: U01-AFXX5R-W008	1 OF 1