

RoHS Compliant

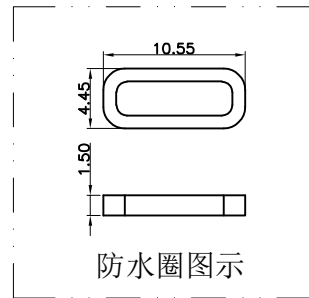
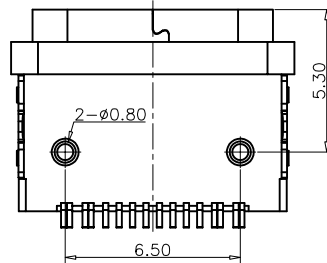
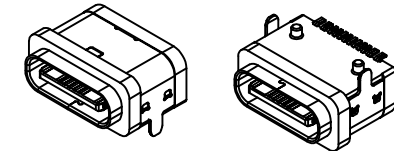
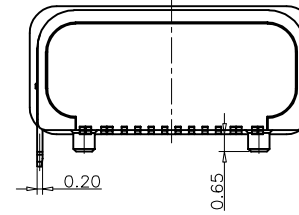
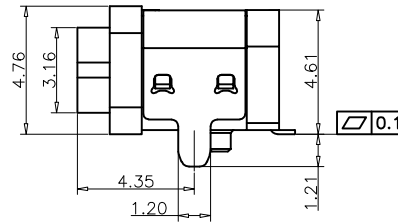
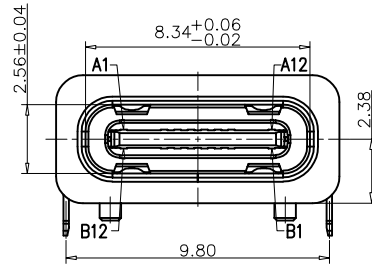
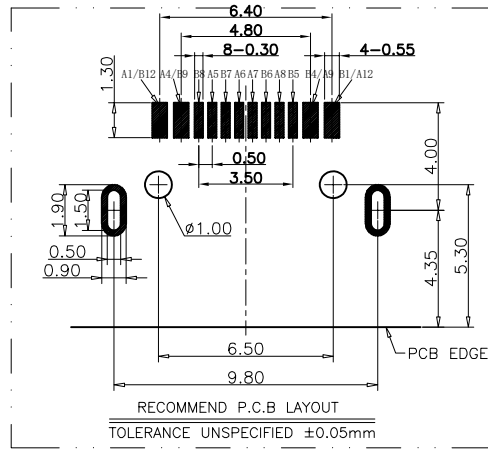
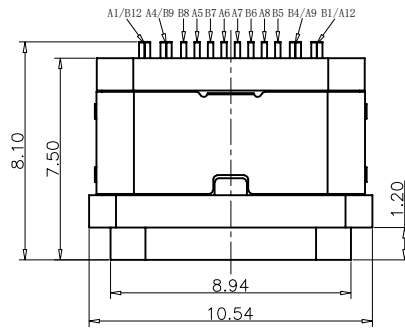

PART NO. INFORMATION

U06-C F X X 5 R - W123

PORT TYPE
C: TYPE C

GENDER
F: FEMALE
M: MALE

CONTACT PLATED
1: GOLD FLASH
2: GOLD 3U"
3: GOLD 5U"
4: GOLD 10U"
5: GOLD 15U"
6: GOLD 30U"

PACKAGE
R: TAPE REEL

HOUSING COLOR
2: WHITE
5: BLACK
9: NATURE

HOUSING MATERIAL
A: LCP B: PBT
C: PA9T D: PA6T
E: PA46 F: PA66

NOTES:

SPECIFICATION:

- CURRENT RATING: 3.0 A
- VOLTAGE RATING: 3.0 V
- VBUS & GND PINS AND OTHER PINS: 40mΩ/PIN MAX
SHIELD: 50mΩ/MAX
LLCR MAX. CHANGE OF ALL PINS: 10Ωm
- INSULATION RESISTANCE: 100MΩ MIN
- DIELECTRIC WITHSTAND VOLTAGE, AC 100V FOR 1MINUTE
- INSERTION FORCE: 0.5~2.0kgf
- UNMATING FORCE: 0.8~2.0kgf
- DURABILITY: 10000 CYCLES
- OPERATING TEMPERATURE: -35°C~+85°C
- THE PEAK TEMPERATURE ON THE BOARD SHALL BE MAINTAINED FOR 10 SECONDS AT 210-250°C
- WATERPROOF: IP-X7.

USB TYPE C PIN ASSIGNMENTS

PIN NUMBER	SIGNAL NAME	PIN NUMBER	SIGNAL NAME
A1	GND	B12	GND
A4	VBUS	B9	VBUS
A5	CC1	B8	SBU2
A6	DP1	B7	DN2
A7	DN1	B6	DP2
A8	SBU1	B5	CC2
A9	VBUS	B4	VBUS
A12	GND	B1	GND

TABLE:

NO	PART	Q'TY	Material
1	PLASTIC SHELL	1	PA&LCP UL94 V-0 BLACK
2	SHELL	1	STAINLESS STEEL, NI PLATED
3	CONTACT	16	COPPER ALLOY, TIN/AU/NI PLATED
4	MD PLATE	1	STAINLESS STEEL, NO PLATING
5	MD HOUSING	1	PA&LCP UL94 V-0 BLACK
6	SHIELDING PLATE	1	STAINLESS STEEL, NI PLATED
7	WATERPROOF RING	1	SILICONE UL94 V-0 RED

Bestcreate Technology Limited

TOLERANCES UNLESS OTHERWISE SPECIFIED:

.X	± 0.20	X.*	± 5°
.XX	± 0.15	.X*	± 2°
.XXX	± 0.10	.XX*	± 1°

Website: www.bsc-elec.com

Email: bestcreate@bsc-elec.com

DESIGN:

I. L

CHECKED:

C. W

APPROVED:

C. W

DATE:

DATE:

DATE:

TITLE:

IPX7 WATERPROOF 16P USB C FEMALE CONNECTOR SMT TYPE

MATERIAL:

FINISH:

PART NO:

DWG NO:

U06-CFXX5R-W123

U06-CFXX5R-W123

SIZE: A4

1 OF 1

REV: A

UNIT mm

SCALE 1=1

QUALITY SYMBOLS

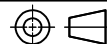

1

2

3

4

5

6

7

8