

RoHS Compliant

REVISIONS			
REV.	DESCRIPTION	DATE	DESIGN

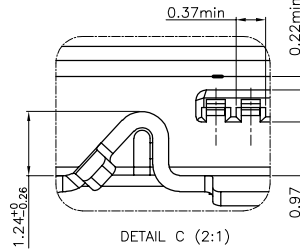

RECOMMENDED P.C.B LAYOUT

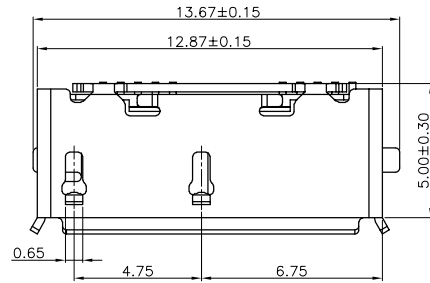
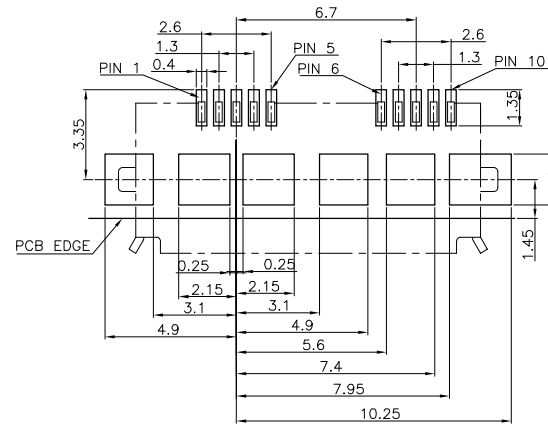

PART NO. INFORMATION

**U04-B F X X 5 R - 006**

PORT TYPE B: TYPE B	PACKAGE R: TAPE REEL
GENDER F: FEMALE M: MALE	HOUSING COLOR 2: WHITE 5: BLACK 9: NATURE
CONTACT PLATED 1: GOLD FLASH 2: GOLD 3U'' 3: GOLD 5U'' 4: GOLD 10U'' 5: GOLD 15U'' 6: GOLD 30U''	HOUSING MATERIAL A: LCP B: PBT C: PA9T D: PA6T E: PA46 F: PA66

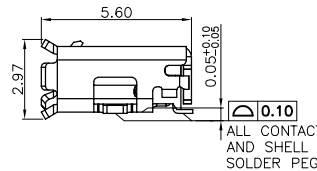
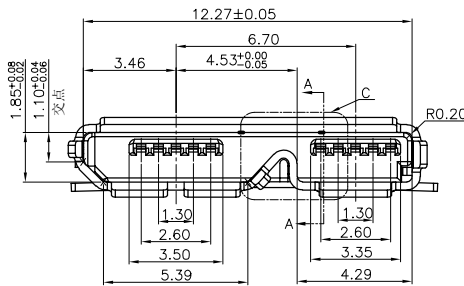

REMARKS:

- MATERIALS
  - HOUSING: LCP UL94V-0
  - TERMINALS: C2680R-H, T=0.15, CONTACT AREA SELECTIVE GOLD PLATED OVER NICKEL, SOLDERING TAIL AREA TIN PLATED OVER NICKEL
  - SHELL: SUS304, T=0.30, NICKEL PLATED
- CHARACTERISTICS
  - CURRENT RATING: 1.5A
  - CONTACT RESISTANCE: 30mΩ MAX
  - INSULATION RESISTANCE: 100MΩ MIN
  - DIELECTRIC WITHSTANDING VOLTAGE: 100V AC
  - SOLDERING: TEMPERATURE 245+/-5°C, 3-5 SECONDS.
  - INSERT FORCE: 3.5kgf MAX, WITHDRAWAL FORCE: 1.00kgf MIN
  - DURABILITY: 10000 CYCLES
  - HEAT RESISTANCE: IR TEST 260+/-10°C
  - OPERATING TEMPERATURE: -20°C~+60°C

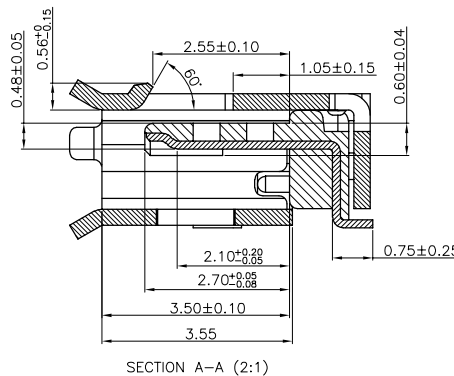
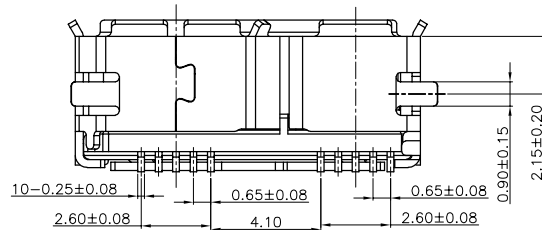

**Bestcreate Technology Limited**

TOLERANCES UNLESS OTHERWISE SPECIFIED:

X.	±	0.50	X.*	±	3'
.X	±	0.25	.X*	±	2'
.XX	±	0.15	.XX*	±	1'

Website: [www.bsc-elec.com](http://www.bsc-elec.com)  
Email: [bestcreate@bsc-elec.com](mailto:bestcreate@bsc-elec.com)

DESIGN: I. L DATE: 2017. 3. 1

CHECKED: C. W DATE: 2017. 3. 1

APPROVED: C. W DATE: 2017. 3. 1

TITLE: MICRO USB 3.0 B/F SMT

MATERILA: PART NO: U04-BFXX5R-006 SIZE: A4

FINSH: DWG NO: U04-BFXX5R-006

REV: A UNIT mm SCALE 1=1 QUALITY SYMBOLS