

RoHS Compliant

REVISIONS			
REV.	DESCRIPTION	DATE	DESIGN

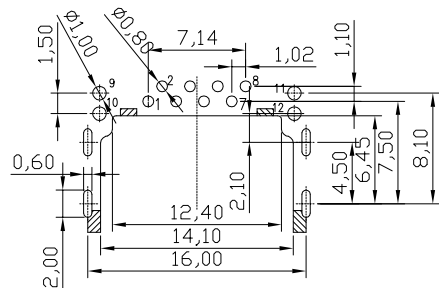

PCBLAOUT T=1.2
TOL:±0.05

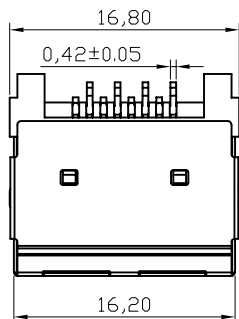
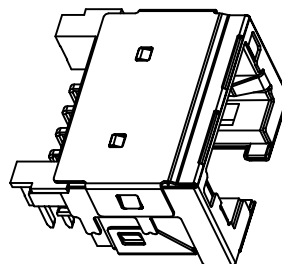

NOTES

- MATERIAL
- 1. HOUSING MATERIAL : LCP BLACK UL94V-0.
 - 2. CONTACT MATERIAL : PHOSPHOR BRONZE T=0.3mm.
 - 3. PLATING : GOLD AND TIN PLATING OVER NICKEL.
 - 4. SHIELD : BRASS WITH NICKEL PLATED.
- ELECTRICAL
- 1. VOLTAGE RATING : 125 VAC RMS.
 - 2. CURRENT RATING : 1.5 AMP.
 - 3. CONTACT RESISTANCE : 40 MILLIOHMS MAX.
 - 4. INSULATION RESISTANCE : 500 MEGOHMS MIN @ 100V DC .
 - 5. DIELECTRIC DIELECTRIC RESISTANCE : 100V DC RMS 50Hz. 1MIN.
- MECHANICAL
- 1. DURRABILITY : 750 CYCLES MIN.
 - 2. MATING/UNMATING FORC: 2.24 KG. F MAX.
- ENVIRONMENTAL:
- 1. STORAGE : -40°C~+85°C.
 - 2. OPERATION : -40°C~+85°C.

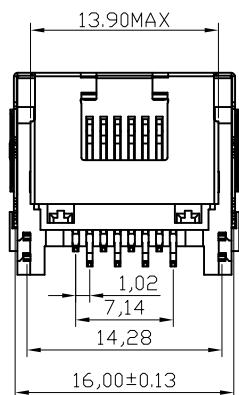
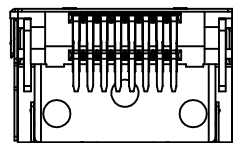
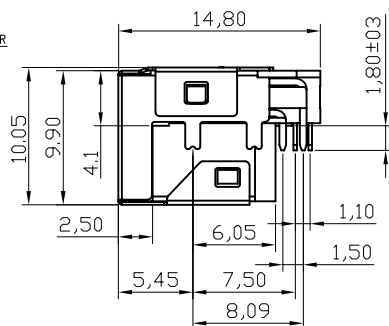
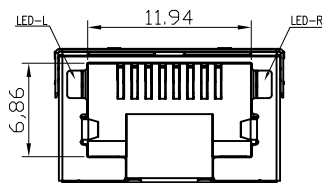

壳子脚

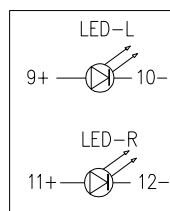
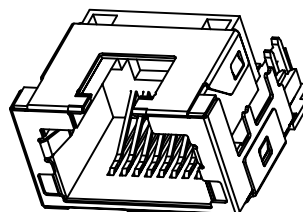

PART NO. INFORMATION

RJ01- X 5 1 X - 038 - X

- CONTACT PLATED
- 1: G/F
 - 2: AU 3U"
 - 3: AU 6U"
 - 4: AU 15U"
 - 5: AU 30U"
- HOUSING:
- 1:LCP BLACK
- PACKAGE
- R: TAPE REEL
 - T: TRAY
- LED:
- 1:L-YELLOW R-GREEN
 - 2:L-GREEN R-YELLOW

Bestcreate Technology Limited

TOLERANCES UNLESS OTHERWISE SPECIFIED:

.X	± 0.30	X.'	± 3'
.XX	± 0.20	.X''	± 2''
.XXX	± 0.10	.XXX'	± 1'

Website: www.bsc-elec.com
Email: bestcreate@bsc-elec.com

DESIGN: I. L. DATE: 2017. 3. 1

CHECKED: C. W. DATE: 2017. 3. 1

APPROVED: C. W. DATE: 2017. 3. 1

TITLE: MID MOUNT 4.1MM RJ45 8P8C FEMALE DIP CONNECTOR REVERSE TYPE, 9.9H, WITH LED LIGHT

MATERILA: PART NO: RJ01-X51X-038-X SIZE: A4

FINSH: DWG NO: RJ01-X51X-038-X

REV: A UNIT mm SCALE 1=1 QUALITY SYMBOLS

1

2

3

4

5

6

7

8