

RoHS Compliant

REVISIONS			
REV.	DESCRIPTION	DATE	DESIGN

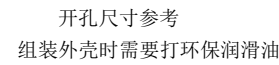

开孔尺寸参考
组装外壳时需要打环润滑油

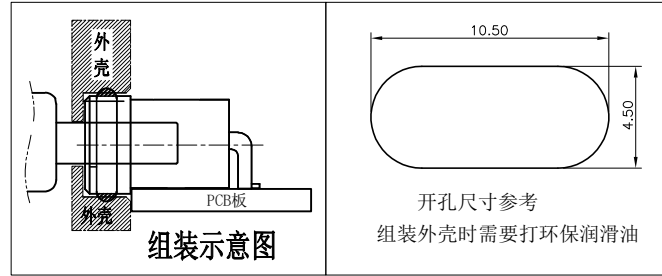
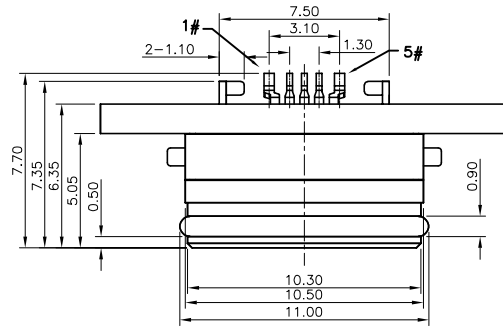
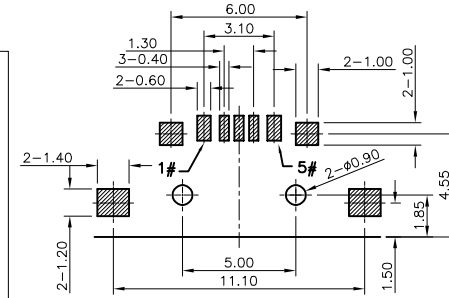

RECOMMENDED P.C.B. LAYOUT (TOP VIEW)
GENERAL TOLERANCE: ±0.05

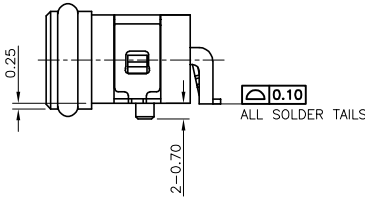
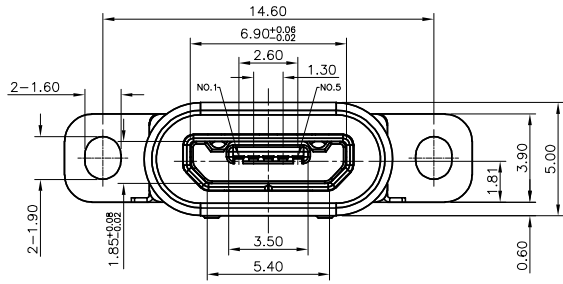

ALL SOLDER TAILS

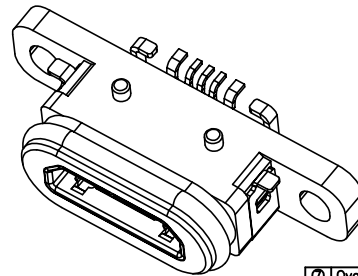
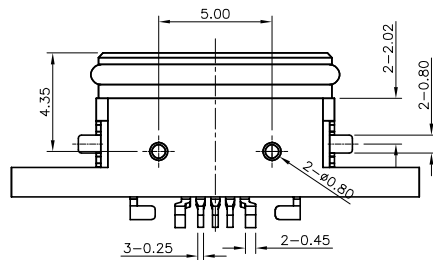

- SPECIFICATIONS:
- ELECTRICAL CHARACTERISTICS:
 - RATING: 3A(PIN1&5),0.5A(PIN2&3&4);
 - CONTACT RESISTANCE: 30 mΩ MAX.(INITIAL);
 - DIELECTRIC WITHSTANDING: 500V AC MIN.;
 - INSULATION RESISTANCE: 1000MΩ MIN.;
 - DURABILITY: 10,000 CYCLES MIN.;
 - INSERTION FORCE: 3.5Kgf (35N) Max.;
 - EXTRACTION FORCE: 0.8Kgf (8N) Min.;
 - WATER PROOFNESS: THIS PRODUCT IS BASED ON IPX8
 - PLUG INTERFACE DIMENSIONS COMFORM TO USB2.0 SPEC.
 - PACKAGING: TAPE & REEL.

PART NO. INFORMATION

U01-B F X 5 R - W023

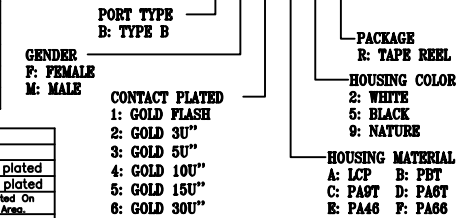

Contact Number	Signal Name	Remarks
1#	VBUS	Power
2#	D-	Date-
3#	D+	Date+
4#	ID	Reserve or Ground
5#	GND	Ground

NO.	DESCRIPTION	QTY	MATERIAL	REMARK
①	Oval ring	1	Rubber	Black
②	Glue	1	---	Black
③	U-shaped frame	1	Copper alloy or stainless	Nickel plated
④	Inner shell	1	Copper alloy or stainless	Nickel plated
⑤	Terminal	5	Copper alloy, 0.15t	Gold Plated On Contact Area
⑥	Outer shell	1	High temperature thermoplastic	Black
⑦	Body	1	High temperature thermoplastic	Black

Bestcreate Technology Limited

TOLERANCES UNLESS OTHERWISE SPECIFIED:

X.	± 0.20	X.*	± 2*
.X	± 0.15	.X*	± 1*
.XX	± 0.10	.XX*	± 0.5*

Website: www.bsc-elec.com
E-mail: bestcreate@bsc-elec.com

DESIGN: I.L DATE: 2017/3/1

CHECKED: C.W DATE: 2017/3/1

APPROVED: C.W DATE: 2017/3/1

TITLE: IPX8 WATERPROOF MICRO USB 2.0 5P B FEMALE CONNECTOR WITH SCREW

MATERIAL: PART NO: U01-BFXX5R-W023 SIZE: A4

FINISH: DWG NO: U01-BFXX5R-W023 SHEET: 1 OF 1

REV: A UNIT mm SCALE 1=1 QUALITY SYMBOLS