

RoHS Compliant

REVISIONS			
REV.	DESCRIPTION	DATE	DESIGN

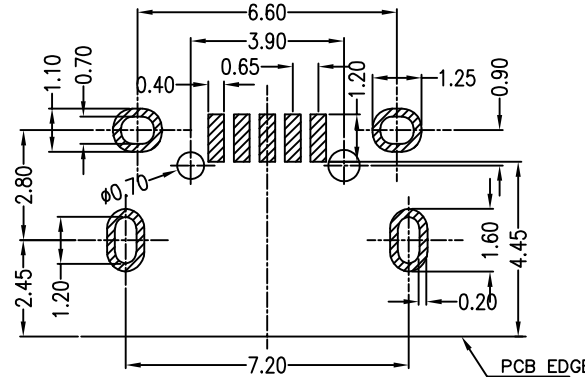
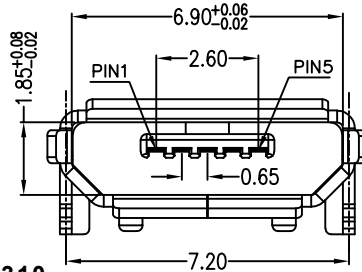
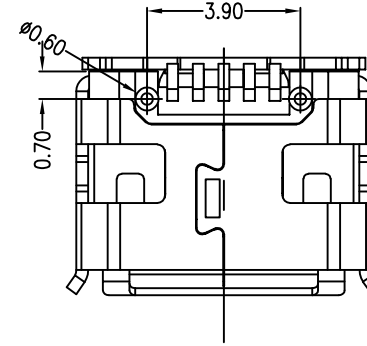
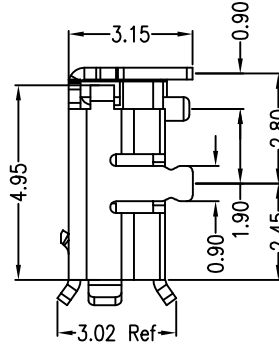
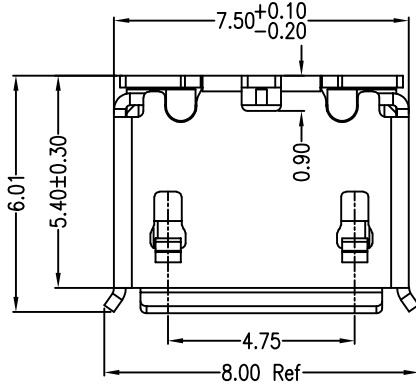
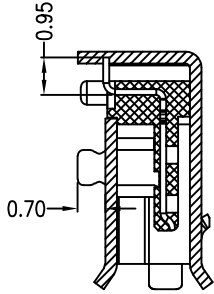
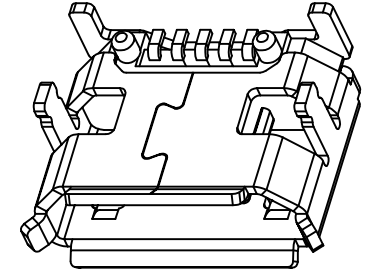
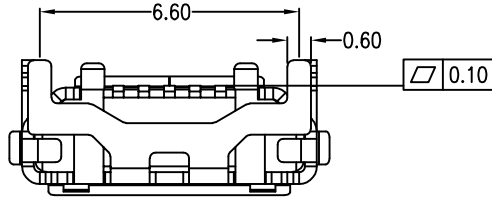

PCB图仅供参考  
RECOMMEND PCB LAYOUT

Note:

1.Material:

- 1.1 Housing: LCP High temperature thermoplastic with g.f,UL94v-0
- 1.2 Contact: copper alloy,t=0.15mm
- 1.3 Shell: SUS304,t=0.30mm

2.Specification:

- 2.1 Current rating:1,5PIN 1.8A Max/2,3,4PIN 1A Max.
- 2.2 Dielectric withstanding voltage: 100 V(ac) for 1 min.
- 2.3 Contact resistance: 30 mΩ Max.
- 2.4 Insulation resistance: 100 MΩ Min.
- 2.5 Total mating force: 3.57 Kgf Max.
- 2.6 Total unmating force: 1.0 Kgf Min.
- 2.7 Temperature range: -30°C~80°C

PART NO. INFORMATION

**U01-B F X X 5 R - 310**

- PORT TYPE  
B: TYPE B
- GENDER  
F: FEMALE  
M: MALE
- CONTACT PLATED  
1: GOLD FLASH  
2: GOLD 3U"  
3: GOLD 5U"  
4: GOLD 10U"  
5: GOLD 15U"  
6: GOLD 30U"
- PACKAGE  
R: TAPE REEL
- HOUSING COLOR  
2: WHITE  
5: BLACK  
9: NATURE
- HOUSING MATERIAL  
A: LCP B: PBT  
C: PA9T D: PA6T  
E: PA46 F: PA66

TOLERANCES UNLESS OTHERWISE SPECIFIED:

.X	± 0.15	X.	± 3°
.XX	± 0.10	.X°	± 2°
.XXX	± 0.05	.XX°	± 1°

Website: [www.bsc-elec.com](http://www.bsc-elec.com)

E-mail: [bestcreate@bsc-elec.com](mailto:bestcreate@bsc-elec.com)

DESIGN: I. L  
DATE: 2017/3/1

CHECKED: C. W  
DATE: 2017/3/1

APPROVED: C. W  
DATE: 2017/3/1

TITLE: **MICRO USB 5S B TYPE**  
**牛角型全插6.60/7.2有柱短针新模**

MATERIAL: PART NO: U01-BFXX5R-310 SIZE: A4

FINISH: DWG NO: U01-BFXX5R-310 SHEET: 1 OF 1

**Bestcreate Technology Limited**

REV: A UNIT mm SCALE 1=1 QUALITY SYMBOLS