

RoHS Compliant

REVISIONS			
REV.	DESCRIPTION	DATE	DESIGN

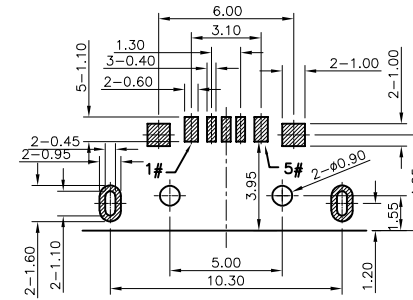

RECOMMENDED P.C.B. LAYOUT (TOP VIEW)
GENERAL TOLERANCE: ±0.05

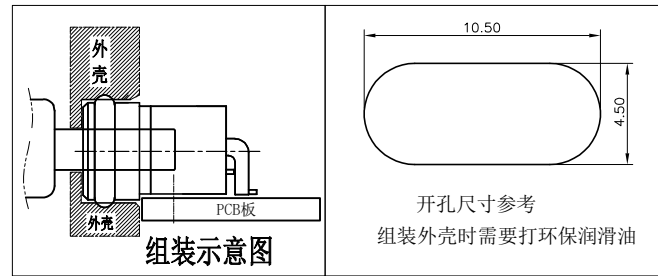
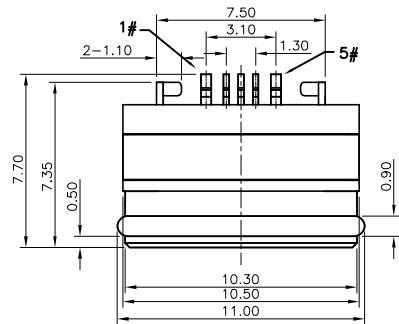
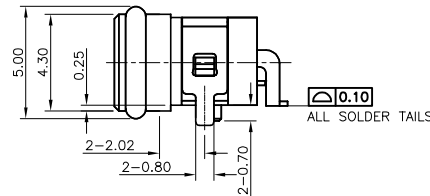
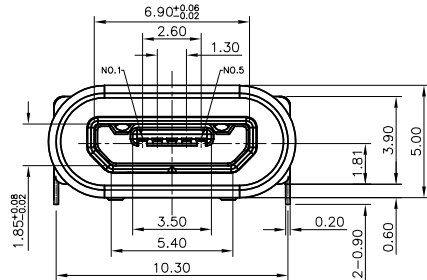

SPECIFICATIONS:

1. ELECTRICAL CHARACTERISTICS:
- 1.1. RATING: 3A(PIN1&5),0.5A(PIN2&3&4);
 - 1.2. CONTACT RESISTANCE: 30 mΩ MAX.(INITIAL);
 - 1.3. DIELECTRIC WITHSTANDING: 500V AC MIN.;
 - 1.4. INSULATION RESISTANCE: 1000MΩ MIN.;
2. DURABILITY: 10,000 CYCLES MIN.;
3. INSERTION FORCE: 3.5Kgf (35N) Max.;
4. EXTRACTION FORCE: 0.8Kgf (8N) Min.;
5. WATER PROOFNESS: THIS PRODUCT IS BASED ON IPX8.
6. PLUG INTERFACE DIMENSIONS CONFORM TO USB2.0 SPEC.
7. PACKAGING: TAPE & REEL.

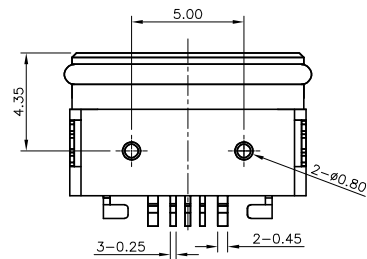

Contact Number	Signal Name	Remarks
1#	VBUS	Power
2#	D-	Date-
3#	D+	Date+
4#	ID	Reserve or Gound
5#	GND	Gound

NO.	DESCRIPTION	QTY	MATERIAL	REMARK
①	Oval ring	1	Rubber	Black
②	Glue	1	-----	Black
③	U-shaped frame	1	Copper alloy or stainless	Nickel plated
④	Inner shell	1	Copper alloy or stainless	Gold Plated On Contact Area
⑤	Terminal	5	Copper alloy, 0.15t	Black
⑥	Outer shell	1	High temperature thermoplastic	Black
⑦	Body	1	High temperature thermoplastic	Black

PART NO. INFORMATION

U01-B F X X 5 R - W025

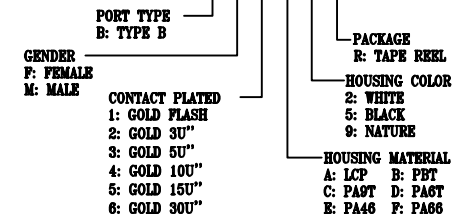

Bestcreate Technology Limited

TOLERANCES UNLESS OTHERWISE SPECIFIED:

X.	± 0.20	X.*	± 2*
.X	± 0.15	.X*	± 1*
.XX	± 0.10	.XX*	± 0.5*

DESIGN: I.L DATE: 2017/3/1

CHECKED: C.W DATE: 2017/3/1

APPROVED: C.W DATE: 2017/3/1

TITLE: IPX8 WATERPROOF MICRO USB 2.0 5P B FEMALE CONNECTOR

MATERILA: PART NO: U01-BFXX5R-W025 SIZE: A4

FINSH: DWG NO: U01-BFXX5R-W025 SHEET: 1 OF 1

REV: A UNIT mm SCALE 1=1 QUALITY SYMBOLS

Website: www.bsc-elec.com E-mail: bestcreate@bsc-elec.com