

RoHS Compliant

REVISIONS			
REV.	DESCRIPTION	DATE	DESIGN

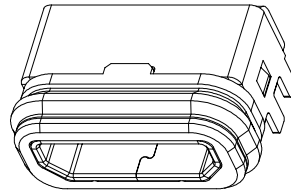

- Note:
- Material:
 - Housing: High temperature thermoplastic
 - Contact: copper alloy, t=0.20mm
 - Shell: SUS304, t=0.30mm
 - cover: High temperature thermoplastic
 - out Shell: SUS304 T=0.25
 - Ring: SILICON
 - Epoxy: Epoxy
 - Specification:
 - Current rating: 1,5PIN 2.0A Max/2,3,4PIN 1A Max.
 - Dielectric withstanding voltage: 100 V(ac) for 1 min.
 - Contact resistance: 30 mΩ Max.
 - Insulation resistance: 100 MΩ Min.
 - Total mating force: 3.57 Kgf Max.
 - Total unmating force: 1.0 Kgf Min.
 - Temperature range: -30°C~80°C
 - Waterproof: IPX68.

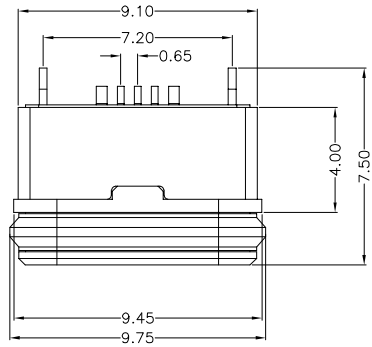
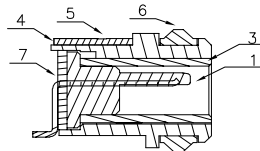
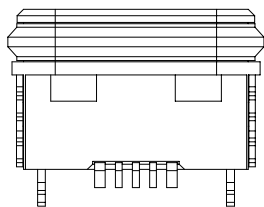
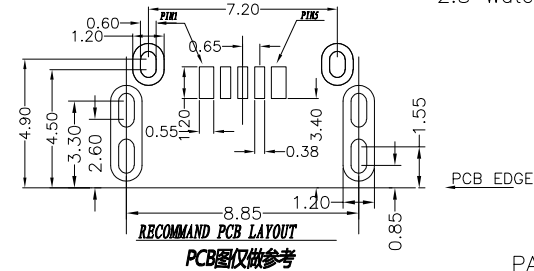
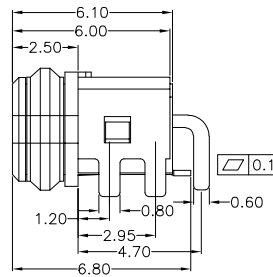
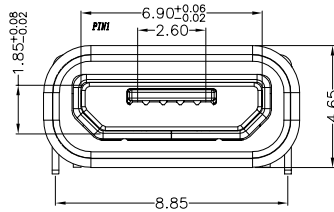

PART NO. INFORMATION

U01-B F X X 5 R - W002

- PORT TYPE: B: TYPE B
- GENDER: F: FEMALE, M: MALE
- CONTACT PLATED: 1: GOLD FLASH, 2: GOLD 3U'', 3: GOLD 5U'', 4: GOLD 10U'', 5: GOLD 15U'', 6: GOLD 30U''
- PACKAGE: R: TAPE REEL
- HOUSING COLOR: 2: WHITE, 5: BLACK, 9: NATURE
- HOUSING MATERIAL: A: LCP, B: PBT, C: PA9T, D: PA6T, E: PA46, F: PA66

Bestcreate Technology Limited

TOLERANCES UNLESS OTHERWISE SPECIFIED:

X.	± 0.30	X.*	± 10°
.X	± 0.20	.X.*	± 8°
.XX	± 0.15	.XX.*	± 5°

Website: www.bsc-elec.com

E-mail: bestcreate@bsc-elec.com

DESIGN: I.L DATE: 2017/3/1

CHECKED: C.W DATE: 2017/3/1

APPROVED: C.W DATE: 2017/3/1

TITLE: WATERPROOF MICRO USB 5P B FEMALE DIP

MATERIAL: PART NO: U01-BFXX5R-W002 SIZE: A4

FINISH: DWG NO: U01-BFXX5R-W002 SHEET: 1 OF 1

REV:	UNIT	SCALE	QUALITY SYMBOLS
A	mm	1=1	