

RoHS Compliant

PITCH 1.0mm BAR TO BAR CONNECTOR

REVISIONS			
REV.	DESCRIPTION	DATE	DESIGN

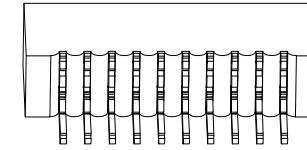
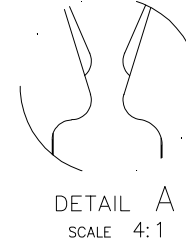
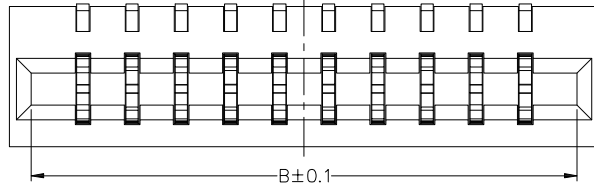

PIN	DIM A	DIM B	DIM C	DIM D
2	1.00	3.10	3.00	4.00
3	2.00	4.10	4.00	5.00
4	3.00	5.10	5.00	6.00
5	4.00	6.10	6.00	7.00
6	5.00	7.10	7.00	8.00
7	6.00	8.10	8.00	9.00
8	7.00	9.10	9.00	10.00
9	8.00	10.10	10.00	11.00
10	9.00	11.10	11.00	12.00
11	10.00	12.10	12.00	13.00
12	11.00	13.10	13.00	14.00
13	12.00	14.10	14.00	15.00
14	13.00	15.10	15.00	16.00
15	14.00	16.10	16.00	17.00
16	15.00	17.10	17.00	18.00
17	16.00	18.10	18.00	19.00
18	17.00	19.10	19.00	20.00
19	18.00	20.10	20.00	21.00
20	19.00	21.10	21.00	22.00
21	20.00	22.10	22.00	23.00
22	21.00	23.10	23.00	24.00
23	22.00	24.10	24.00	25.00
24	23.00	25.10	25.00	26.00
25	24.00	26.10	26.00	27.00
26	25.00	27.10	27.00	28.00
27	26.00	28.10	28.00	29.00
28	27.00	29.10	29.00	30.00
29	28.00	30.10	30.00	31.00
30	29.00	31.10	31.00	32.00
31	30.00	32.10	32.00	33.00
32	31.00	33.10	33.00	34.00
33	32.00	34.10	34.00	35.00
34	33.00	35.10	35.00	36.00

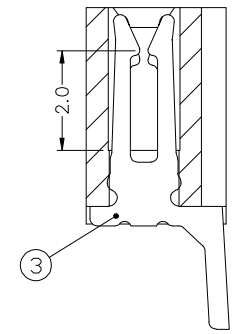
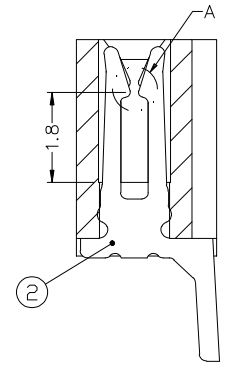
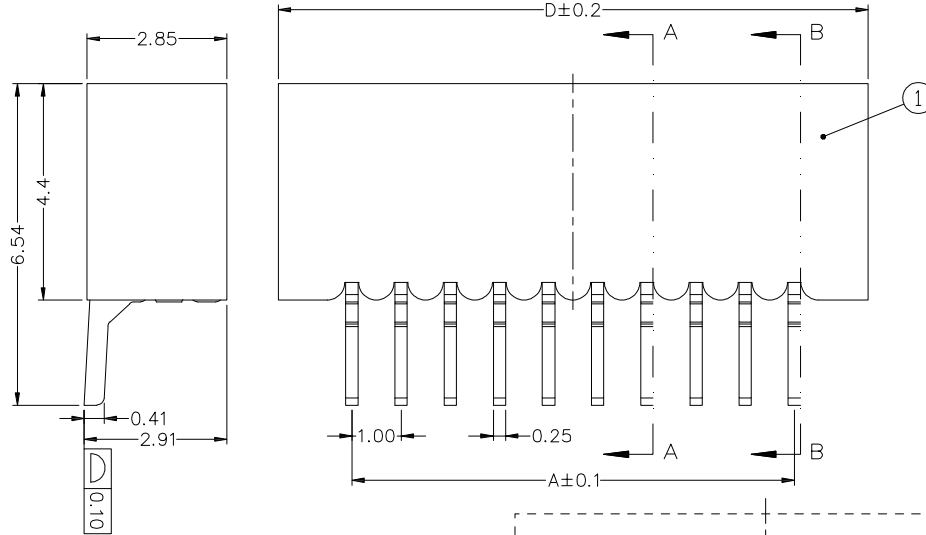

SECTION A-A

SECTION B-B

Electrical
 rated current:0.5A AC(rms)/DC
 nominal voltage:50V AC(rms)/DC
 Dielectric Withstanding Voltage:500V AC/rms
 Contact Resistance:≤30mΩ max(initial)
 Insulation Resistance:800 MΩ min
 Operating Temp:-20°C~+85°C

③	TERMINAL	PHOSPHOR BRONZE	PDR-1B-S020
②	TERMINAL	PHOSPHOR BRONZE	PDR-1B-S019
①	HOUSING	LCR(BLACK)UL94V-0	LOC-NY
SERIAL NUMBER	NAMER	MATERIALS	PART NUMBER

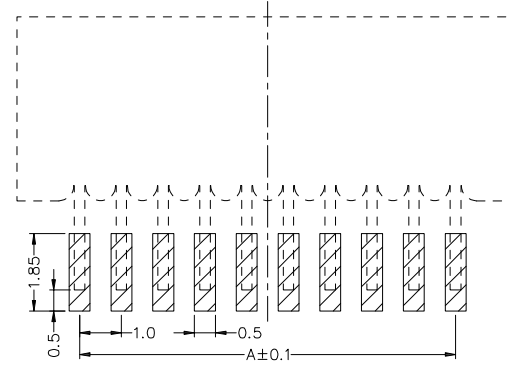

PC BOARD LAYOUT

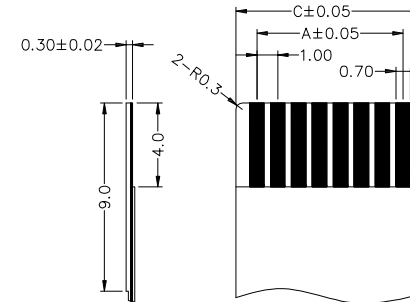

PROPER CABLE (SCALE 2:1)

PART NO. INFORMATION

FPC10-XX 0 1 X -B002

NO. OF CONTACTS: 1
 PACKAGE: T-TUBE
 PLATING: O: TIN, G: GOLD FLASH
 R-TAPE&REEL
 1:ROHS, 2: HALOGEN FREE

Bestcreate Technology Limited

TOLERANCES UNLESS OTHERWISE SPECIFIED:
 .X ± 0.50 .X* ± 2*
 .XX ± 0.20 .X' ± 1*
 .XXX ± 0.05 .XX' ± 0.5*

Website:www.bsc-elec.com
 Email:bestcreate@bsc-elec.com

DESIGN: I.L DATE: 2017. 3. 1
 CHECKED: DATE:
 C.W 2017. 3. 1
 APPROVED: DATE:
 C.W 2017. 3. 1

TITLE: 1.0mm 双面接卧贴
 MATERIAL: PART NO: FPC10-XX01X-B002 SIZE: A4
 FINISH: DWG NO: FPC10-XX01X-B002

REV: A	UNIT: mm	SCALE: 1=1	QUALITY SYMBOLS:
--------	----------	------------	------------------