

RoHS Compliant

REVISIONS			
REV.	DESCRIPTION	DATE	DESIGN

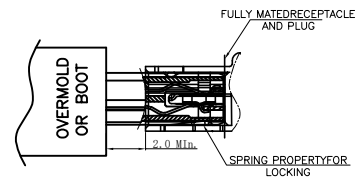
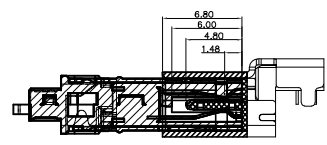
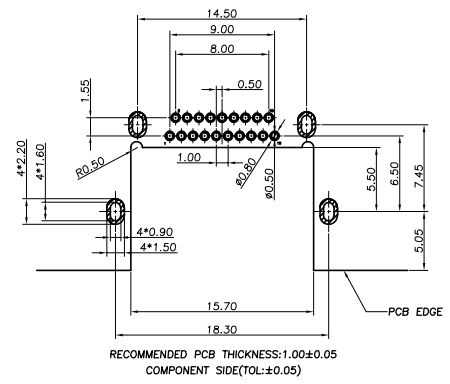
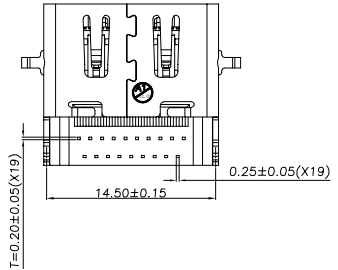
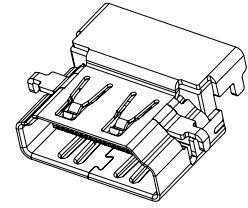
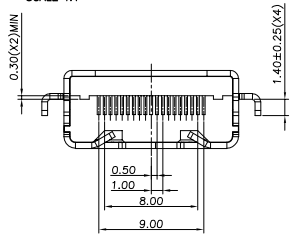
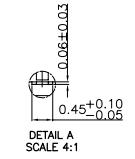
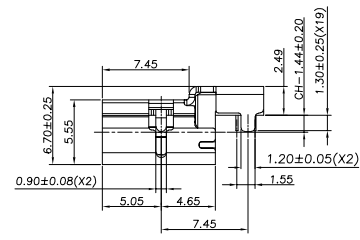
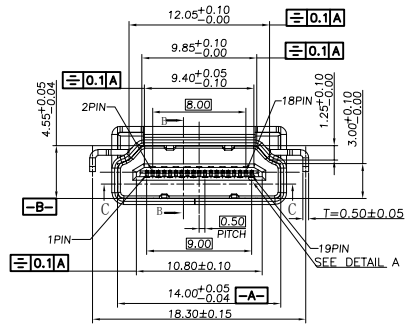
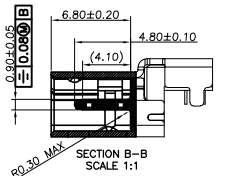
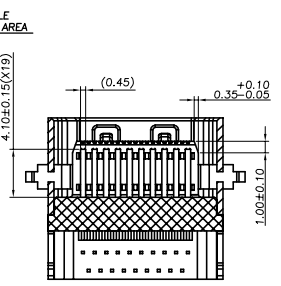
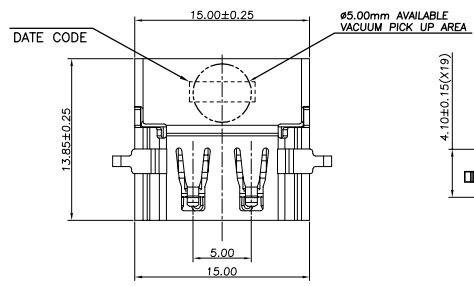

PART NO. INFORMATION

HD01-A F X X 5 R - 026

- PORT TYPE  
A: TYPE A
- GENDER  
F: FEMALE  
M: MALE
- PACKAGE  
R: TAPE REEL
- HOUSING COLOR  
2: WHITE  
5: BLACK  
9: NATURE
- CONTACT PLATED  
1: GOLD FLASH  
2: GOLD 3U''  
3: GOLD 5U''  
4: GOLD 10U''  
5: GOLD 15U''  
6: GOLD 30U''
- HOUSING MATERIAL  
A: LCP B: PBT  
C: PA9T D: PA6T  
E: PA46 F: PA66

PIN	SIGNAL ASSIGNMENT	PIN	SIGNAL ASSIGNMENT	PIN	SIGNAL ASSIGNMENT
1	TMS DATA2+	8	TMS DATA SHIELD	15	SEL
2	TMS DATA2 SHIELD	9	TMS DATA-	16	SDA
3	TMS DATA2-	10	TMS CLOCK+	17	D0C/CEC GROUND
4	TMS DATA1+	11	TMS CLOCK + SHIELD	18	+5V POWER
5	TMS DATA1 SHIELD	12	TMS CLOCK-	19	HOT PLUG DETECT
6	TMS DATA1-	13	CEC		
7	TMS DATA2+	14	UEP/NEK+		

C	SHELL	1	MATAL/SEE TABLE A
B	TERMINAL	19	COPPER YELLOW/SEE TABLE A
A	HOUSING	1	HTERNOPLASTIC UL94V-0 BLACK
NO	PART NAME	QTY	MATERIAL PLATING & COLOR

Bestcreate Technology Limited

TOLERANCES UNLESS OTHERWISE SPECIFIED:		DESIGN:	DATE:
X.	± 0.50	I. L	2017. 3. 1
.X	± 0.30	CHECKED:	DATE:
.XX	± 0.20	C. W	2017. 3. 1
Tel/Whatsapp: 0086-13712299763		APPROVED:	DATE:
Skype: belle.wu3340		C. W	2017. 3. 1

TITLE:		
HDMI A TYPE 19PIN H=6.70 CH=-1.44MM, L=13.85MM REC, RVS, DIP TYPE		
MATERILA:	PART NO:	SIZE:
	HD01-AFXX5R-026	A4
FINSH:	DWG NO:	
	HD01-AFXX5R-026	

REV:	UNIT	SCALE	QUALITY SYMBOLS
A	mm	1=1	