

RoHS Compliant

REVISIONS			
REV.	DESCRIPTION	DATE	DESIGN

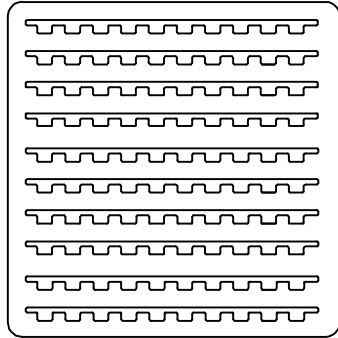

2000PCS/CARTON UP COVER

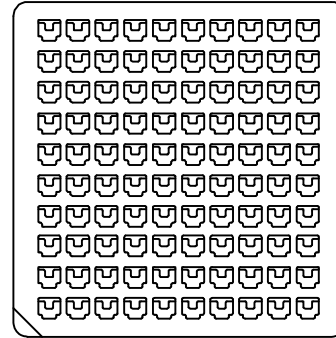

BOTTOM COVER

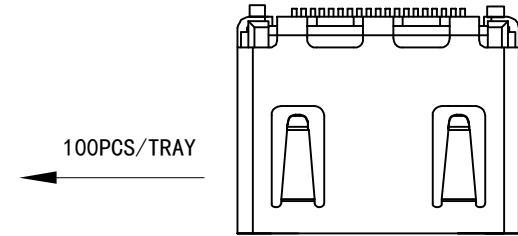

100PCS/TRAY

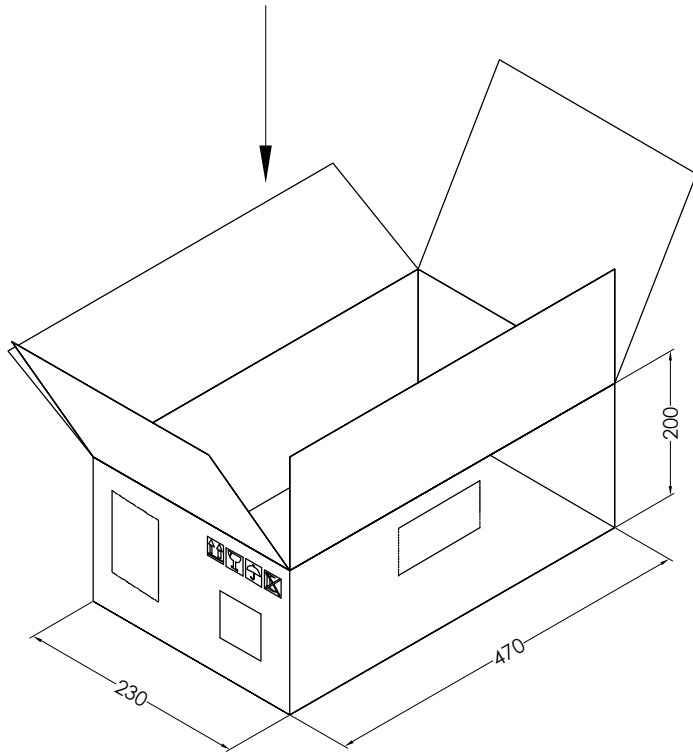

NOTE:
 1.PACKING:100PCS/TRAY,2000PCS/CARTON.
 2.CARTON SIZE: 470*230*200mm

Bestcreate Technology Limited

TOLERANCES UNLESS OTHERWISE SPECIFIED:			
X.	±	0.15	X.' ± 5'
.X	±	0.10	.X' ± 2'
.XX	±	0.08	.XX' ± 1'
.XXX	±	0.03	.XXX' ± 0.5'

DESIGN:	DATE:
I.L	2017/7/5
CHECKED:	DATE:
C.W	2017/7/5
APPROVED:	DATE:
C.W	2017/7/5

TITLE: HDMI AF SMT外壳四脚同线插板无耳(插PIN式)		
MATERILA:	PART NO:	SIZE:
	HD01-AFXX5R-006	A4
FINSH:	DWG NO:	SHEET:
	HD01-AFXX5R-006	2 OF 3

REV: A	UNIT: mm	SCALE: 1=1	QUALITY SYMBOLS
--------	----------	------------	-----------------

Website:www.bsc-elec.com
 Email:bestcreate@bsc-elec.com

RoHS Compliant

REVISIONS			
REV.	DESCRIPTION	DATE	DESIGN

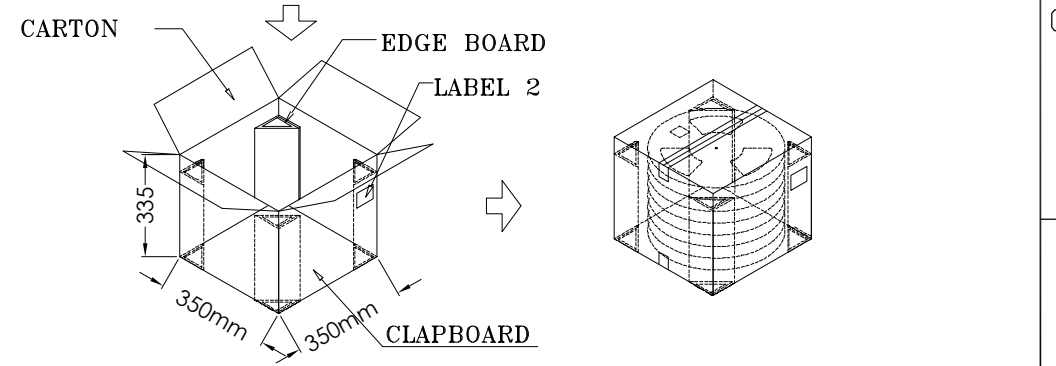
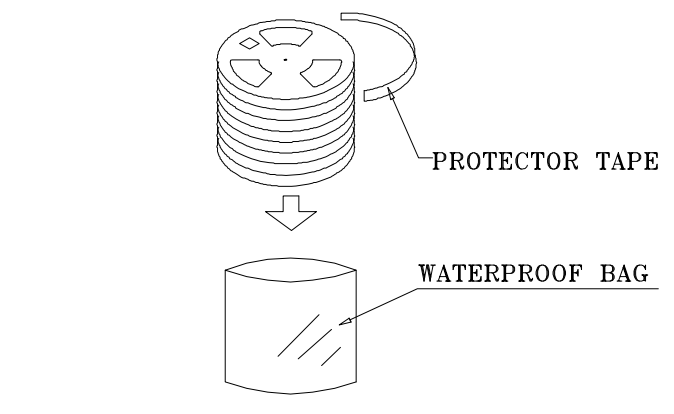
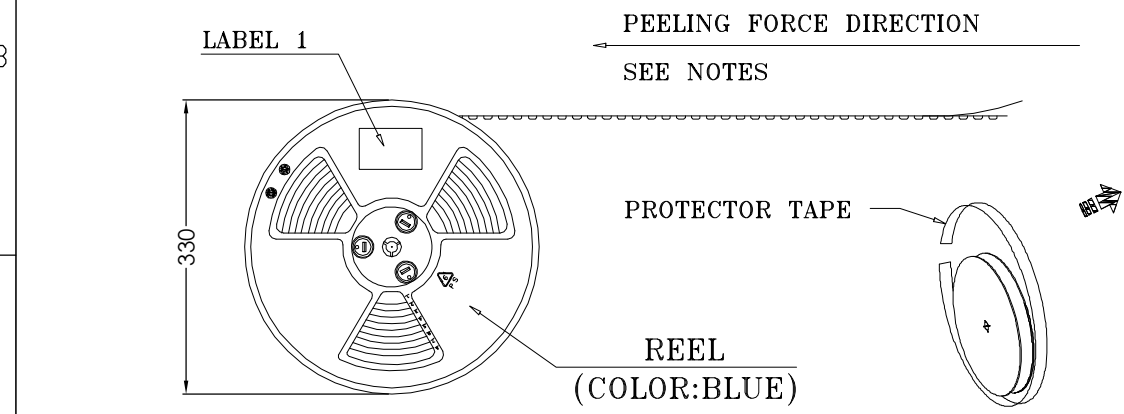
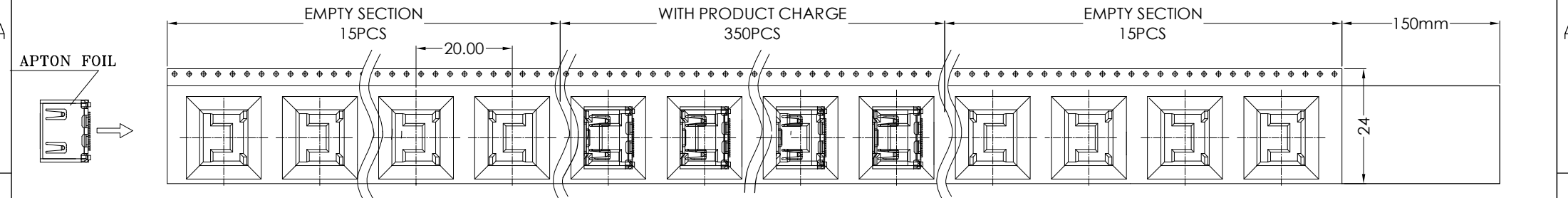

Notes:
 1.DIMENSION:
 CARTON: 350*350*335mm,A=A(1PCS)
 EDGE BOARD: 400*310mm(4PCS)
 CLAPBOARD: 330*330mm(2PCS)
 2.QUANTITY:
 350PCS/REEL
 10REELS/SHIPPING CARTON
 3500PCS/SHIPPING CARTON

Bestcreate Technology Limited

REV: A	UNIT: mm	SCALE: 1=1	QUALITY SYMBOLS
--------	----------	------------	-----------------

TOLERANCES UNLESS OTHERWISE SPECIFIED:			
X.	± 0.15	X.'	± 5'
.X	± 0.10	.X'	± 2'
.XX	± 0.08	.XX'	± 1'
.XXX	± 0.03	.XXX'	± 0.5'

Website: www.bsc-elec.com
 Email: bestcreate@bsc-elec.com

DESIGN: I.L 2017/7/5	DATE:
CHECKED: C.W 2017/7/5	DATE:
APPROVED: C.W 2017/7/5	DATE:

TITLE: HDMI AF SMT外壳四脚同线插板无耳(插PIN式)		
MATERILA:	PART NO: HD01-AFXX5R-006	SIZE: A4
FINSH:	DWG NO: HD01-AFXX5R-006	SHEET: 3 OF 3