

RoHS Compliant

REVISIONS			
REV.	DESCRIPTION	DATE	DESIGN

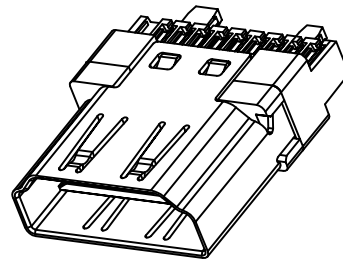
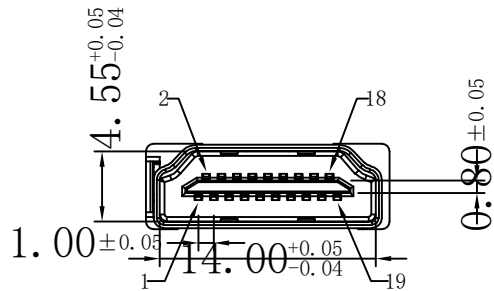

NOTE :

1.SPECIFICATION:

- 1.1.CURRENT RATING: 0.5 Amp Max.
- 1.2.VOLTAGE RATING: 40 V ac(r.m.s) Max.
- 1.3.CONTACT RESISTANCE: 10m ohms Max.mated
- 1.4.INSULATION RESISTANCE:100M ohms Min.
- 1.5.DIELECTRIC WITHSTANDING VOLTAGE:
AC 500V Min. (for 1 minute)

- 1.6.OPERATION TEMPERATURE RANGE: -25°C~85°C

2.MECHANICAL

- 2.1 INSERTION FORCE: 4.5KGF MAXMUM
- 2.1 WITHDRAWAL FORCE: 1.0KGF MINIMUM; 4.0KGF MAXMUM

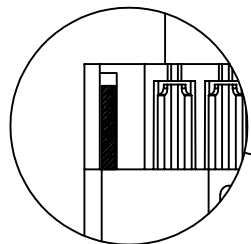

红色区为
地线片

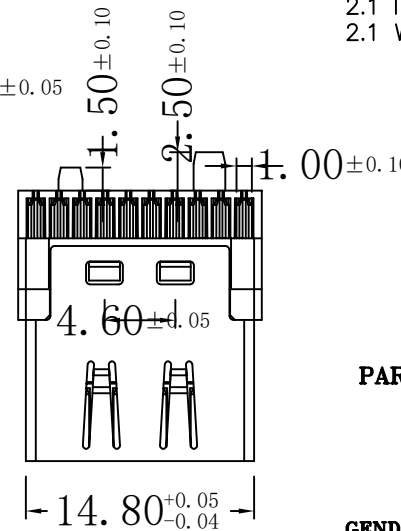
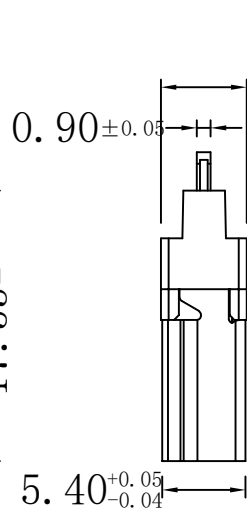
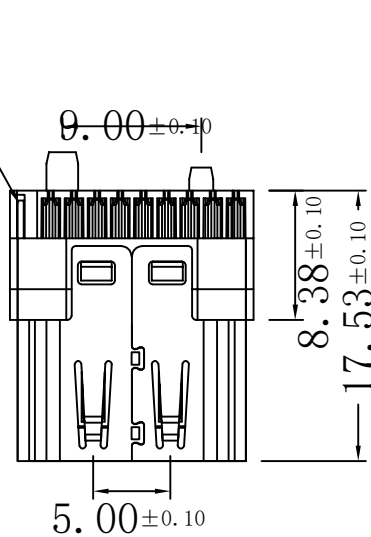

PART NO. INFORMATION

HD01-A F X X 5 T - 018

- PORT TYPE
A: TYPE A
- GENDER
F: FEMALE
M: MALE
- CONTACT PLATED
1: GOLD FLASH
2: GOLD 3U"
3: GOLD 5U"
4: GOLD 10U"
5: GOLD 15U"
6: GOLD 30U"
- PACKAGE
T: TRAY
- HOUSING COLOR
2: WHITE
5: BLACK
9: NATURE
- HOUSING MATERIAL
A: LCP B: PBT
C: PA9T D: PA6T
E: PA46 F: PA66

Bestcreate Technology Limited

TOLERANCES UNLESS OTHERWISE SPECIFIED:

X.	± 0.50	X.*	± 3'
.X	± 0.25	.X*	± 2'
.XX	± 0.15	.XX*	± 1'

Tel/Whatsapp:0086-13712299763
Skype: belle.wu3340

DESIGN:

I. L

CHECKED:

C. W

APPROVED:

C. W

DATE:

2017. 3. 1

DATE:

2017. 3. 1

DATE:

2017. 3. 1

TITLE:

HDMI A TYPE FEMALE CONNECTOR

MATERILA:

FINSH:

PART NO:

DWG NO:

HD01-AFX5T-018

HD01-AFX5T-018

SIZE:

A4

REV:
A

UNIT
mm

SCALE
1=1

QUALITY
SYMBOLS



1

2

3

4

5

6

7

8

RoHS Compliant

REVISIONS			
REV.	DESCRIPTION	DATE	DESIGN

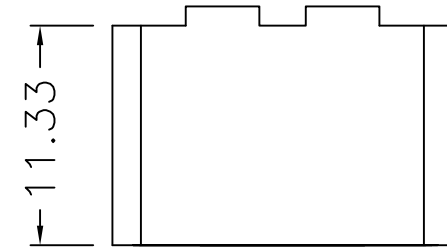
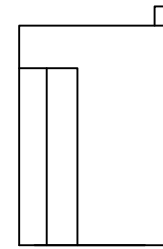
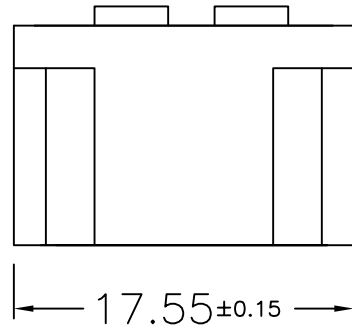
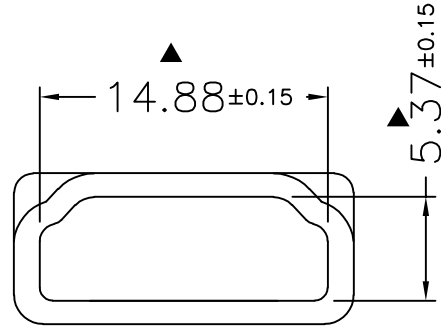

NOTES:

1. 外观不得有缩水、缺胶、毛边、色差等不良。
2. 标有"▲"为重点尺寸。
3. 材质: PBT BLACK.
4. 与HDMI母头配合紧密无松动。

Bestcreate Technology Limited

TOLERANCES UNLESS OTHERWISE SPECIFIED:

X.	± 0.50	X.*	± 3'
.X	± 0.25	.X*	± 2'
.XX	± 0.15	.XX*	± 1'

DESIGN: I. L. DATE: 2017. 3. 1

CHECKED: C. W. DATE: 2017. 3. 1

APPROVED: C. W. DATE: 2017. 3. 1

TITLE: HDMI 19P AF JACKET

MATERILA:	PART NO: HD01-AFX5T-018	SIZE: A4
FINSH:	DWG NO: HD01-AFX5R-018	

Tel/Whatsapp:0086-13712299763
Skype: belle.wu3340

REV: A	UNIT: mm	SCALE: 1=1	QUALITY SYMBOLS:
--------	----------	------------	------------------

RoHS Compliant

REVISIONS			
REV.	DESCRIPTION	DATE	DESIGN

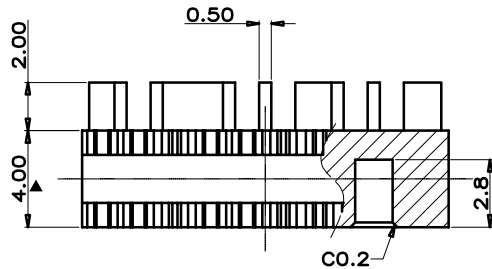
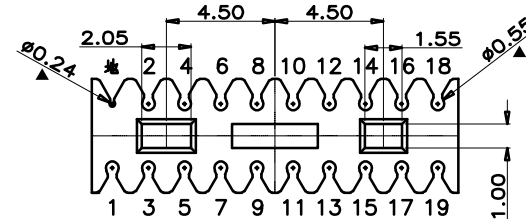
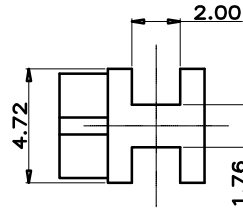
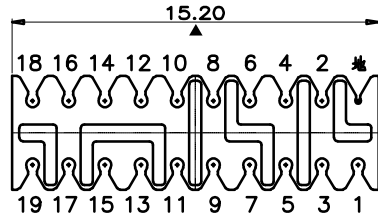

备注:

1. 材料:PA66 + 15%G/F, 颜色:黑色。
2. 每一处尺寸都必须在公差范围内, 即使因制造需要拔模的也一样。
3. 上, 下表面, 侧面, 舌片, PIN孔槽内表面, 毛边0.05mm Max, 其他部位毛边0.05mm MAX.
4. 穴号标记凸出0.05mm MAX.
5. 材质须符合ROHS要求。
6. 线夹定位孔尺寸不符情况下与插头实配为主。
7. 产品无起泡, 缺胶, 变形等不良现象。

Bestcreate Technology Limited

TOLERANCES UNLESS OTHERWISE SPECIFIED:

X.	± 0.50	X.*	± 3'
.X	± 0.25	.X*	± 2'
.XX	± 0.15	.XX*	± 1'

Tel/Whatsapp:0086-13712299763
Skype: belle.wu3340

DESIGN: I. L DATE: 2017. 3. 1

CHECKED: C. W DATE: 2017. 3. 1

APPROVED: C. W DATE: 2017. 3. 1

TITLE: HDMI 19P AF JACKET

MATERILA:	PART NO: HD01-AFX5T-018	SIZE: A4
FINSH:	DWG NO: HD01-AFX5T-018	

REV: A	UNIT mm	SCALE 1=1	QUALITY SYMBOLS
--------	---------	-----------	-----------------