

RoHS Compliant

REVISIONS			
REV.	DESCRIPTION	DATE	DESIGN

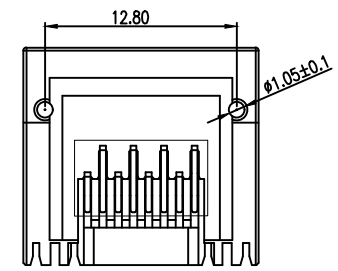
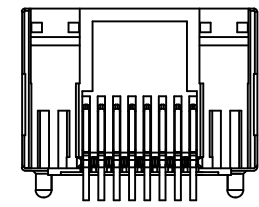
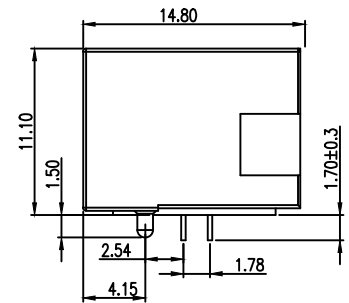
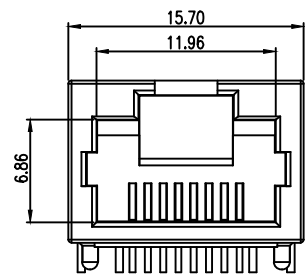
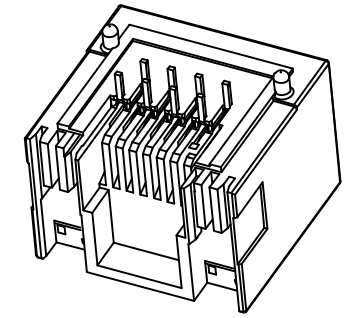
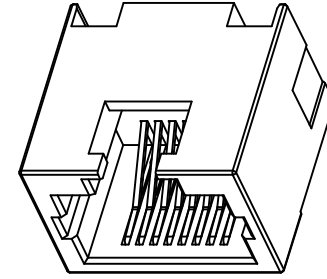
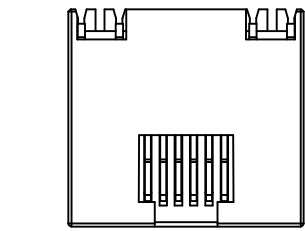
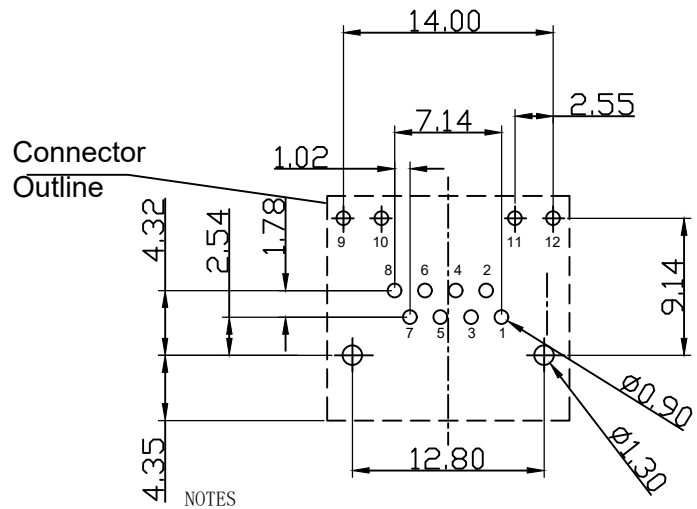

NOTES

- MATERIAL**
- 1. HOUSING MATERIAL : PA9T/PA46/LCP BLACK UL94V-0.
 - 2. CONTACT MATERIAL : PHOSPHOR BRONZE T=0.3mm.
 - 3. PLATING : 3u Au PLATING ON CONTACT AREA, AND TIN PLATING ON SOLDER AREA OVER NICKEL.
- ELECTRICAL**
- 1. VOLTAGE RATING : 125 VAC RMS.
 - 2. CURRENT RATING : 1.5 AMP.
 - 3. CONTACT RESISTANCE : 40 MILLIOHMS MAX.
 - 4. INSULATION RESISTANCE : 500 MEGOHMS MIN @ 100V DC .
 - 5. DIELECTRIC DIELECTRIC RESISTANCE : 500V DC RMS 50Hz. 1MIN.
- MECHANICAL**
- 1. DURRABILITY : 750 CYCLES MIN.
 - 2. MATING/UNMATING FORC: 2.24 KG. F MAX.
- ENVIRONMENTAL:**
- 1. OPERATION : -40°C~+85°C.
 - 2. STORAGE : -40°C~+85°C.

PART NO. INFORMATION

RJ01- X 5 4 X - 047

CONTACT PLATED
 1: G/F 2: AU 3U"
 3: AU 6U" PACKAGE
 R: TAPE REEL
 T: TRAY

HOUSING:
 1:LCP BLACK
 2.PBT BLACK
 3.PA46 BLACK
 4.PA9T BLACK

Bestcreate Technology Limited

TOLERANCES UNLESS OTHERWISE SPECIFIED:		DESIGN:	DATE:	TITLE:	
.X ± 0.35	X.* ± 3'	I. L	2017. 3. 1	RJ45 8P8C FEMALE CONNECTOR TAB UP DIP	
.XX ± 0.25	.X.* ± 2'	CHECKED:	DATE:	MATERILA:	PART NO:
.XXX ± 0.15	.XX.* ± 1'	C. W	2017. 3. 1	FINSH:	RJ01-X54X-047
Website:www.bsc-elec.com		APPROVED:	DATE:	DWG NO:	RJ01-X54X-047
Email:bestcreate@bsc-elec.com		C. W	2017. 3. 1	SIZE:	A4

REV: A	UNIT mm	SCALE 1=1	QUALITY SYMBOLS
--------	---------	-----------	-----------------