

RoHS Compliant

REVISIONS			
REV.	DESCRIPTION	DATE	DESIGN

Specifications

Current Rating: 1.0Amp
 Insulation Resistance: 100MΩ Min.
 Dielectric Withstanding: 30V AC
 Contact Resistance: 30MΩ Max.
 Operating Temperature: -40°C to +85°C

Materials

Contact Material: Copper Alloy
 Insulation Material: Polyester, UL 94V-0 Nylon 9T
 All materials must be ROHS materials

A

A

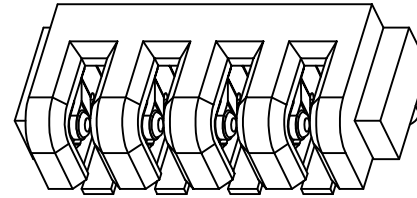
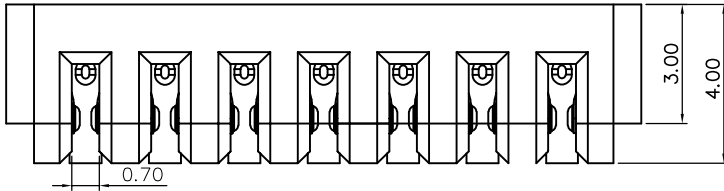

B

B

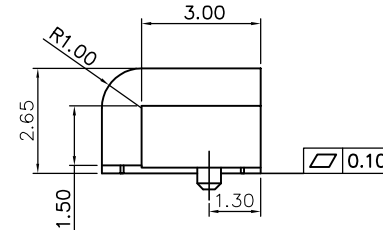
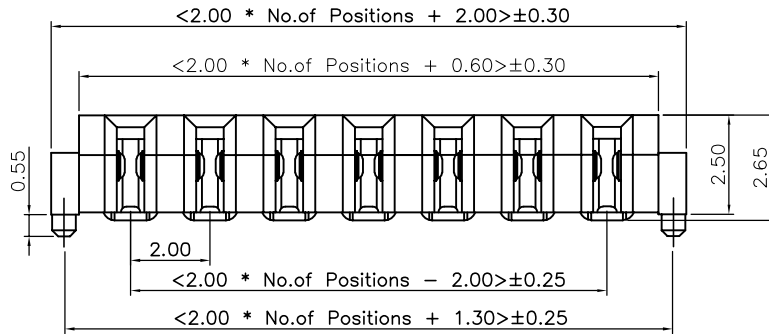

Recommended P.C.Board Hole Layout
 (Tolerance: ±0.05)

C

C

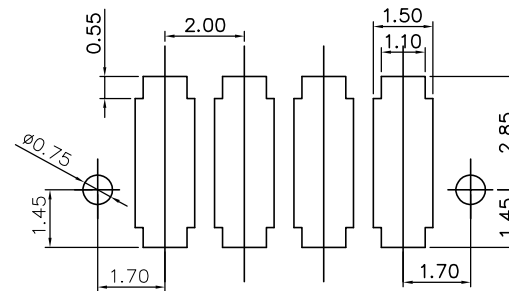
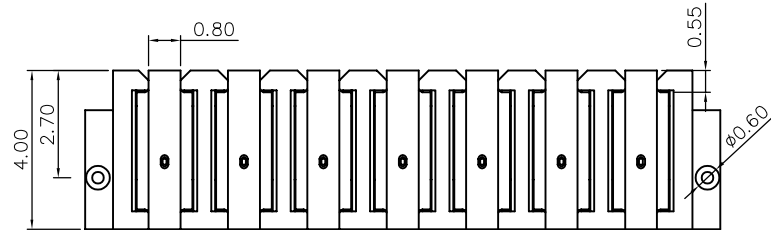

PART NO. INFORMATION

BH200-XX F X C 5 T - 001

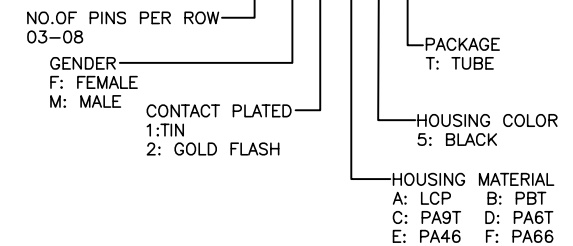

D

D

Bestcreate Technology Limited

TOLERANCES UNLESS OTHERWISE SPECIFIED:

X.	± 0.30	X.*	± 5'
.X	± 0.25	.X.*	± 3'
.XX	± 0.15	.XX.*	± 2'

DESIGN:	DATE:
I. L	2017. 3. 1
CHECKED:	DATE:
C. W	2017. 3. 1
APPROVED:	DATE:
C. W	2017. 3. 1

TITLE: 2.0MM BATTERY HOLDER FEMALE DIP TYPE		
MATERILA:	PART NO: BH200-XXFXC5T-001	SIZE: A4
FINSH:	DWG NO: BH200-XXFXC5T-001	

Website: www.bsc-elec.com
 Email: bestcreate@bsc-elec.com

REV: A	UNIT: mm	SCALE: 1=1	QUALITY SYMBOLS
--------	----------	------------	-----------------