

RoHS Compliant

REVISIONS			
REV.	DESCRIPTION	DATE	DESIGN

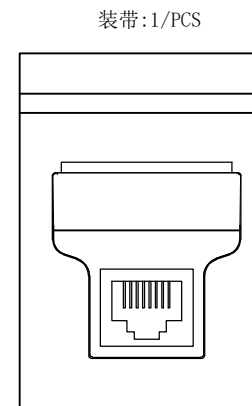
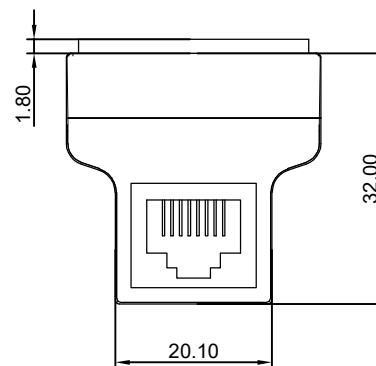
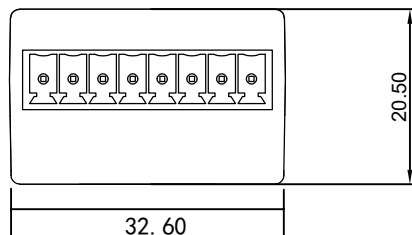
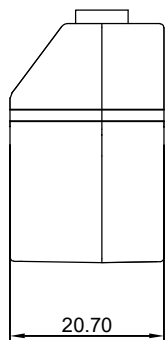
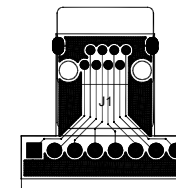
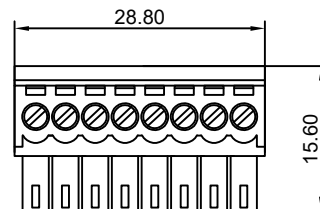
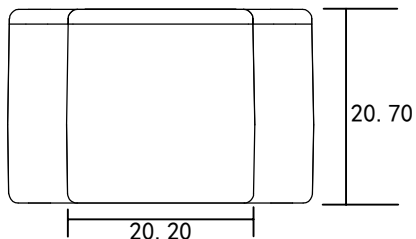
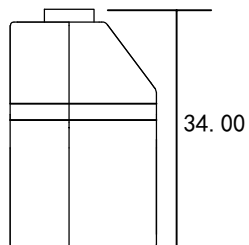

装带:1/PCS

PS: 1.100%Open circuit, short circuit, dislocation, instantaneous short-circuit /open circuit test;
 2.Conductor Resistance: ≤5 Ω
 3.ROHS APPROVED;

6	PE BAG	20501010017	90*60(开边)透明骨袋		1PCS
5	OUTER MOLDING	20301010001	45P-001 PVC BLACK CALIFORNIA65		
4	PLUG	20208020004	15EDGK 8P 3.5PITCH TERMINAL BLOCK FEMALE TERMINAL 90DEGREE		1PCS
3	PLUG	20208020003	15EDGK 8P 3.5PITCH TERMINAL BLOCK MALE		1PCS
2	PLUG	20202050002	RJ45FEMALE 21.15*13.6*15.88 SHIELDING CASE		2PCS
1	PCB	20208030002	RJ45 ETHERNET 8P TERMIALN BLOCK 3.5P GREEN PCB THICKNESS 1.5MM		1PCS
編號 (NO.)	材料名称 MATERIAL	物料编码 BOM	規格 SPECIFICATION	顏色 COLOR	數量 QTY

Bestcreate Technology Limited

TOLERANCES UNLESS OTHERWISE SPECIFIED:

X.	± 0.35	X'	± 3'
.X	± 0.30	.X'	± 2'
.XX	± 0.25	.XX'	± 1'

DESIGN:

DATE:

I. L

2017. 3. 1

CHECKED:

DATE:

C. W

2017. 3. 1

APPROVED:

DATE:

C. W

2017. 3. 1

TITLE:

RJ45 FEMALE TO SCRES TERMINAL BLOCK CONNECTOR 3.5MM PITCH 90DEGREE

MATERILA:

PART NO:

S-5960-RJT08PTN-90

SIZE:

A4

FINSH:

DWG NO:

S-5960-RJT08PTN-90

REV: A

UNIT mm

SCALE 1=1

QUALITY SYMBOLS

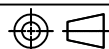

Website:www.bsc-elec.com

Email:bestcreate@bsc-elec.com

1

2

3

4

5

6

7

8