

NOTES:

- 1)MATERIAL:  
HOUSING: LCP UL 94V-0  
CONTACT: CS210R-H,T=0.15  
SHELL: SUS201,T=0.15  
MYLAR: POLYESTER
- 2)FINISH:  
CONTACT:GOLD FLASH PLATED ON CONTACT AREA;  
GOLD FLASH PLATING ON SOLDER TAILS, WITH  
ENTIRE CONTACT UNDERPLATED 30u"Min. NICKEL  
SHELL: 50u"Min. NICKEL UNDERPLATED OVERALL,  
GOLD FLASH PLATED ON SOLDER TAILS
- 3)INFRARED REFLOW SOLDERING: 10sec. Min. at 260±1°
- 4)Operating Temperature:-25 TO+70°
- 5) Mating Cycles:3000 Insertions
- 6)PART NUMBER INFORMATION:

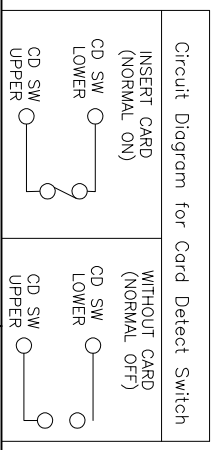

TOLERANCES UNLESS OTHERWISE SPECIFIED:

X	± 0.35	X'	± 5'
.XX	± 0.25	.X'	± 2'
.XXX	± 0.15	.XX'	± 1'

DESIGN: DATE: 2017.3.1

CHECKED: DATE: 2017.3.1

APPROVED: DATE: 2017.3.1

Website:www.bsc-elec.com  
Email:bestcreate@bsc-elec.com

PART NUMBER INFORMATION:

**MSIM -08 X X 5 R - 007**

- 08:08P
- CONTACT PLATED
- 1: GOLD FLASH
- 2: GOLD 30"
- 3: GOLD 50"
- 4: GOLD 10U"
- 5: GOLD 15U"
- 6: GOLD 30U"
- HOUSING COLOR
- 2: WHITE
- 5: BLACK
- 9: NATURE
- PACKAGE
- R: TAPE REEL
- HOUSING MATERIAL
- A: LCP B: PBT
- C: PA9T D: PA6T
- E: PA46 F: PA66

TITLE: PUSH SIM CARD 6+2PIN

2.20H 加长型

MATERIAL: PART NO: MSIM-08XX5R-007 SIZE: A4

FINSH: DWG NO: MSIM-08XX5R-007 SHEET: 1 OF 2

PIN NO.	DESCRIPTION
P1#	C1:VCC
P2#	C5:GND
P3#	C2:RST
P4#	C6:VPP
P5#	C3:CLK
P6#	C7:I/O
P7#	POL
P8#	DET

# Bestcreate Technology Limited

REV: A	UNIT mm	SCALE 1=1	QUALITY SYMBOLS	1	2	3	4	5	6	7	8
--------	---------	-----------	-----------------	---	---	---	---	---	---	---	---

RoHS Compliant

图一

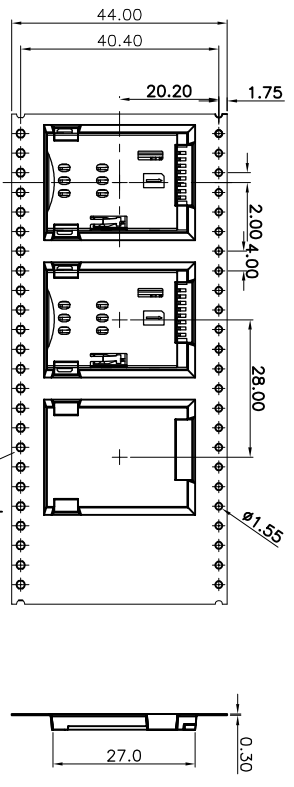
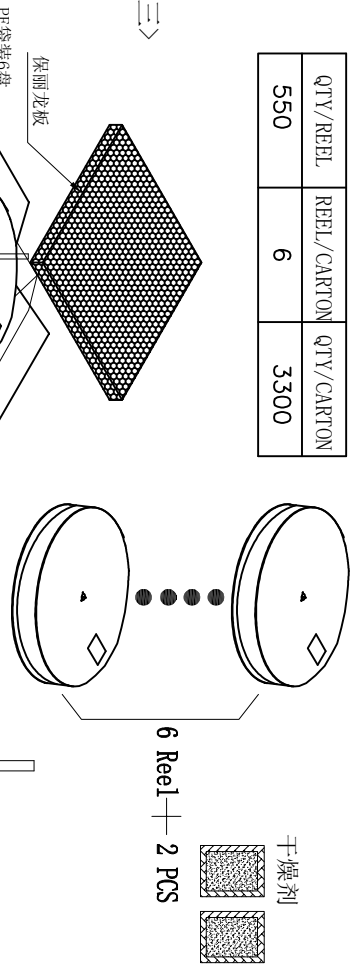

TABLE 1 > PACKAGING QUANTITY

QTY/REEL	REEL/CARTON	QTY/CARTON
550	6	3300

图三



放料方向

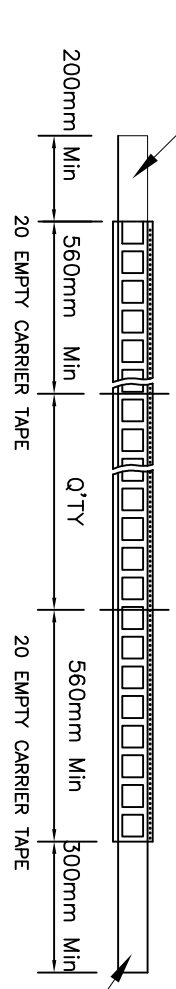

图二

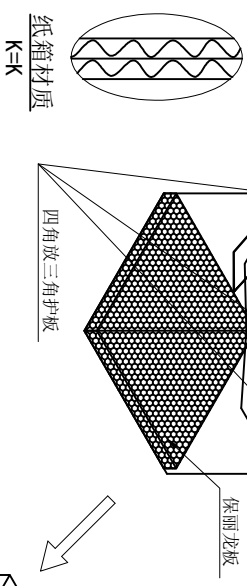
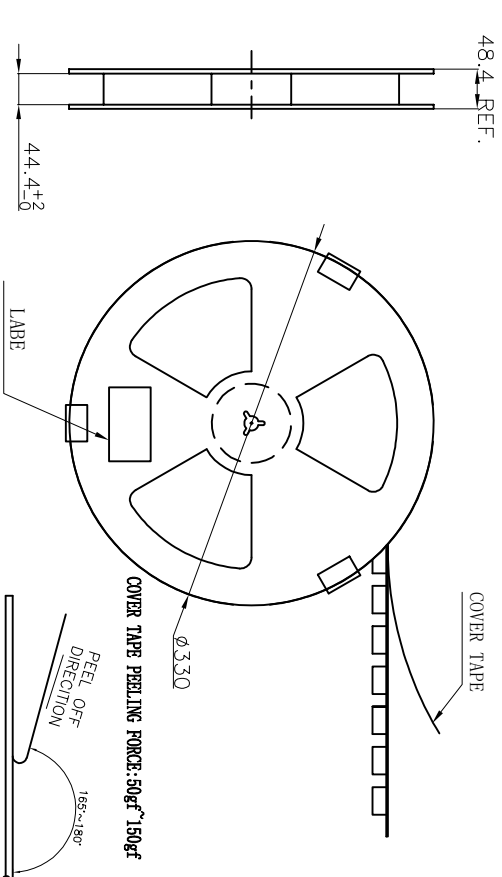

- 备注:
1. 依图一所示放置产品于Carrier tape中, 每次放置1PCS产品, Carrier tape卷绕时, 前端和尾端各需预留20PCS空格.
  2. Cover tape覆盖Carrier tape前端需超出200mmMIN, 后端需留出300mmMIN, 两端都以美文胶贴固.
  3. 包装机包好后, 在Reel的个等分点贴上胶带, 以防止REEL张开, 每Reel贴1PCS标签, 如图二所示
  4. 包装数量见如图三所示
  5. 包装成箱见如图三所示
  6. 封箱, 在封好的纸箱侧面中间位置贴上出货标签.

TOLERANCES UNLESS OTHERWISE SPECIFIED:

Φ	±	0.35	X'	±	5'
.XX	±	0.25	X'	±	2'
.XXX	±	0.15	XX'	±	1'

DESIGN: DATE: 2017.3.1

CHECKED: DATE: 2017.3.1

APPROVED: DATE: 2017.3.1

TITLE: SIM CARD PUSH 6+2PIN

2. 2H (侦测一体) 加长型 包装图

MATERIA: PART NO: MSIM-08XX5R-007

FINSH: DWG NO: MSIM-08XX5R-007

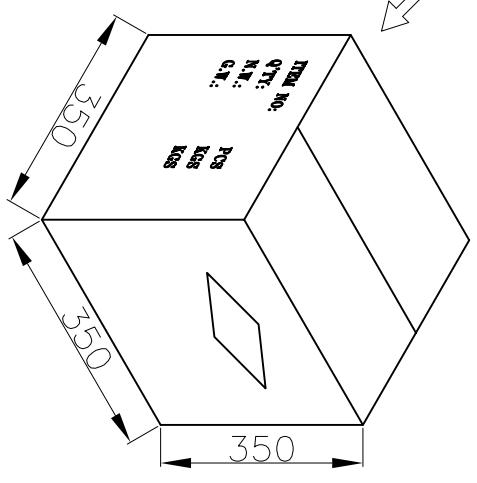

# Bestcreate Technology Limited

REV: A UNIT mm SCALE 1=1 QUALITY SYMBOLS

Website: www.bsc-elec.com  
Email: bestcreate@bsc-elec.com

DATE: 2017.3.1

SIZE: A4 SHEET: 2 OF 2