

RoHS Compliant

REVISIONS			
REV.	DESCRIPTION	DATE	DESIGN

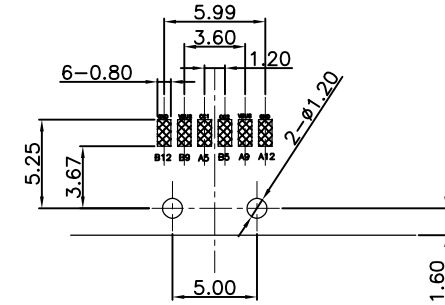

Recommended P.C.B. Layout
Unspecified tolerance: ±0.05
(Top view)

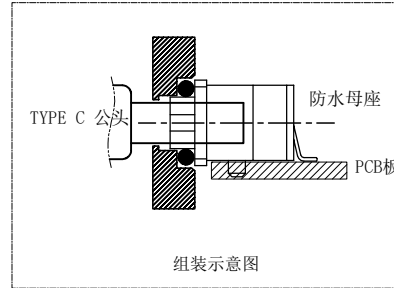
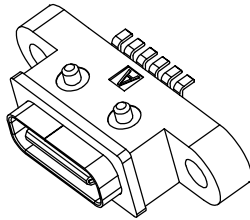
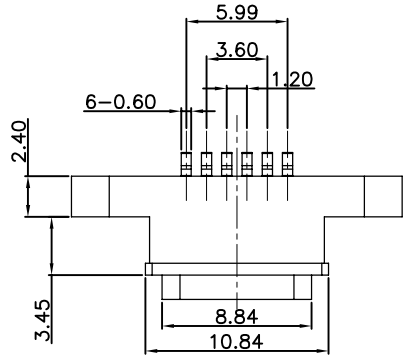
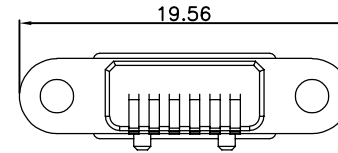
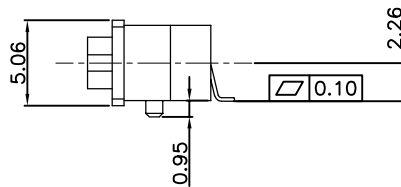
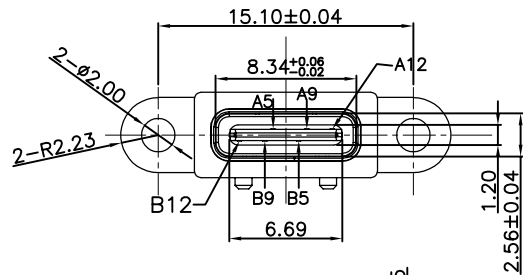

- NOTES:
SPECIFICATION:
- CURRENT RATING: 3.0A MAX
 - DIELECTRIC WITHSTAND VOLTAGE: 100VAC
 - TEMPERATURE RANGE: -30 °C ~ 85 °C
 - CONTACT RESISTANCE: 40 MILLIONHM MAX
 - INSULATION RESISTANCE: 100 MEGOHMS MIN.
 - INSERTION FORCE : 5N~20N
 - UNMATING FORCE: 8N~20N
 - DURABILITY:5,000 CYCLES

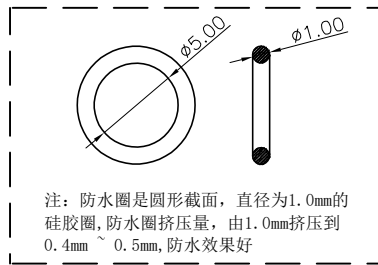
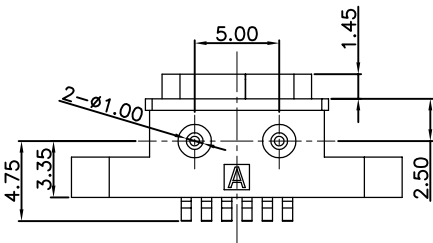

ITEM	PART NAME	Q'TY	FINISH	NOTE
5	Shell2	1	SUS301 Ni Plating T=0.20mm	Ni:40~120u";
4	Shell1	1	SUS301 Ni Plating T=0.25mm	Ni:40~120u";
3	Housing2	1	LCP(G.F30%)	
2	Contact	5	Phosphor bronze C5210R-EH Au/Ni Plating T=0.20mm	Ni:40~160u"; Au:CONTACT AREA:3u", OTHER AREA:G/F
1	Housing	1	PA9T (G.F30%)	

A5	CC1	B12	GND
A9	VBUS	B9	VBUS
A12	GND	B5	CC2
PIN	SIGNAL NAME	PIN	SIGNAL NAME

PART NO. INFORMATION

U06-C F X X 5 R - W089

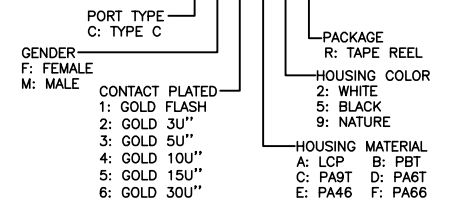

Bestcreate Technology Limited

TOLERANCES UNLESS OTHERWISE SPECIFIED:

X.	± 0.50	X.*	± 5*
.X	± 0.30	.X.*	± 2*
.XX	± 0.10	.XX.*	± 1*

Website:www.bsc-elec.com
Email:bestcreate@bsc-elec.com

DESIGN: I.L DATE:

CHECKED: C.W DATE:

APPROVED: C.W DATE:

TITLE:
IPX8 WATERPROOF 6P USB C FEMALE CONNECTOR SMT TYPE

MATERILA: PART NO: U06-CFXX5R-W089 SIZE: A4

FINSH: DWG NO: U06-CFXX5R-W089 1 OF 1

REV: A UNIT mm SCALE 1=1 QUALITY SYMBOLS