

RoHS Compliant

REVISIONS			
REV.	DESCRIPTION	DATE	DESIGN

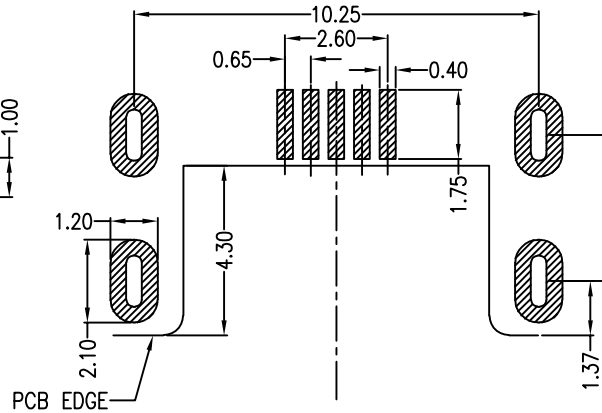
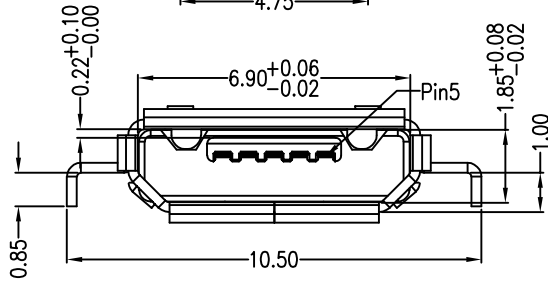
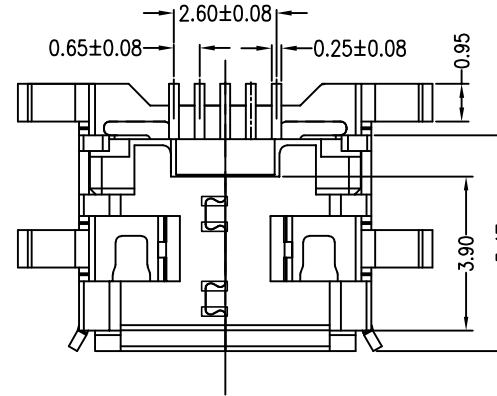
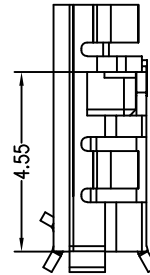
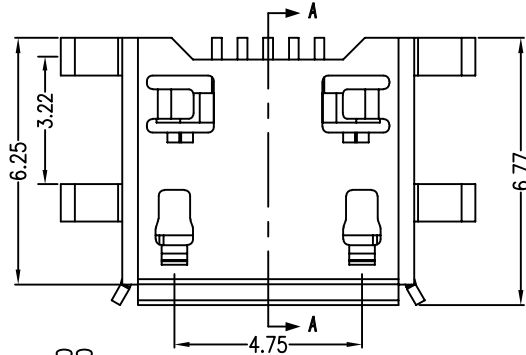
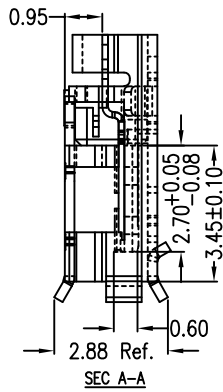
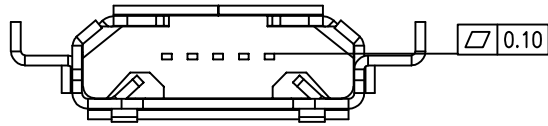

Note:

1.Material:

- 1.1 Housing: High temperature thermoplastic with g.f,UL94v-0
- 1.2 Contact: copper alloy,t=0.15mm
- 1.3 Shell: copper alloy,t=0.25mm

2.Specification:

- 2.1 Current rating:1,5PIN 1.8A Max/2,3,4PIN 1A Max.
- 2.2 Dielectric withstanding voltage: 100 V(ac) for 1 min.
- 2.3 Contact resistance: 30 mΩ Max.
- 2.4 Insulation resistance: 100 MΩ Min.
- 2.5 Total mating force: 3.57 Kgf Max.
- 2.6 Total unmating force: 1.0 Kgf Min.
- 2.7 Temperature range: -30°C~80°C

PART NO. INFORMATION

U01-B F X X 5 R -514

- PORT TYPE
B: TYPE B
- GENDER
F: FEMALE
M: MALE
- CONTACT PLATED
1: GOLD FLASH
2: GOLD 3U"
3: GOLD 5U"
4: GOLD 10U"
5: GOLD 15U"
6: GOLD 30U"
- PACKAGE
R: TAPE REEL
- HOUSING COLOR
2: WHITE
5: BLACK
9: NATURE
- HOUSING MATERIAL
A: LCP B: PBT
C: PA9T D: PA6T
E: PA46 F: PA66

RECOMMENDED PCB LAYOUT

PCB图仅供参考

Bestcreate Technology Limited

TOLERANCES UNLESS OTHERWISE SPECIFIED:

.X	± 0.15	.X'	± 3'
.XX	± 0.10	.X''	± 2'
.XXX	± 0.05	.XXX'	± 1'

DESIGN: I. L
DATE: 2023/4/1

CHECKED: C. W
DATE: 2023/4/1

APPROVED: C. W
DATE: 2023/4/1

TITLE: Micro usb 5s B Type沉板1.0四脚插

MATERIAL: PART NO: U01-BFXX5R-514 SIZE: A4

FINISH: DWG NO: U01-BFXX5R-514 SHEET: 1 OF 1

REV: A UNIT mm SCALE 1=1 QUALITY SYMBOLS

Website: www.bsc-elec.com
E-mail: bestcreate@bsc-elec.com

1

2

3

4

5

6

7

8