

RoHS Compliant

REVISIONS			
REV.	DESCRIPTION	DATE	DESIGN

A

B

C

D

A

B

C

D

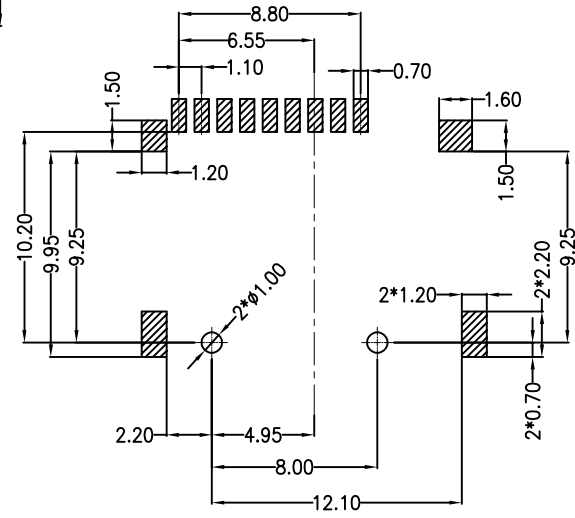
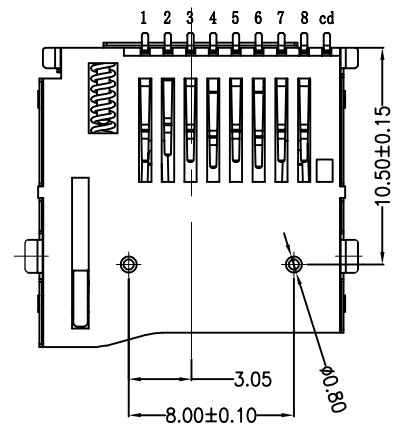
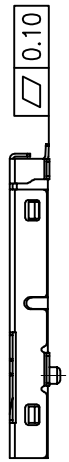
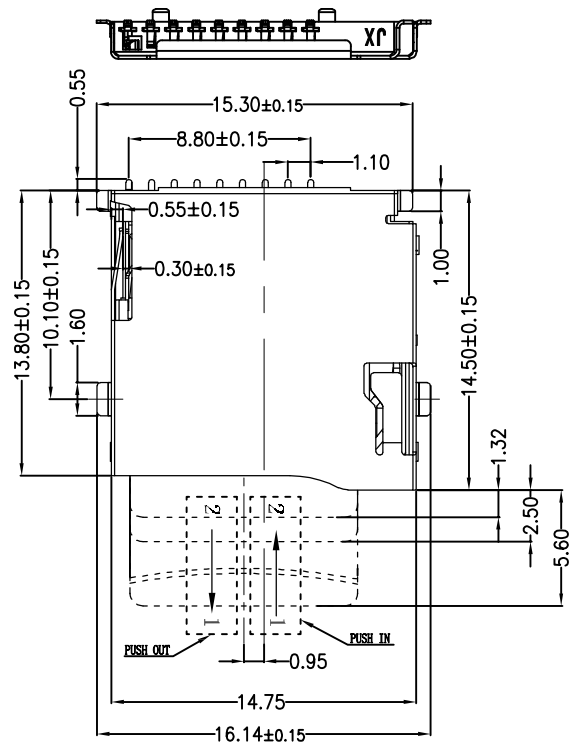
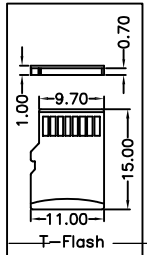
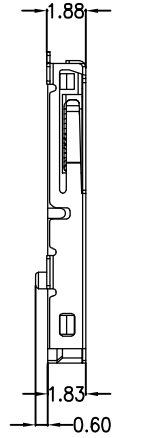

(RECOMMENDED/P.C.B)HOLE LAYOUT  
COMPONENT SIDE VIEW TOLERANCE: + -0.05

NOTES:

- MATERIAL.  
HOUSING: HIGH TEMPERATURE THERMOPLASTIC UL94V\_0,COLOR:BLACK.  
CONTACT: COPPER ALLOYS.  
COVER: STEEL.
- PLATING:  
a.Contact:  
UNDERPLATE: NICKEL.  
CONTACT AREA: GOLD-PLATED  
SOLDER AREA: TIN PLATING  
b.Shell:  
UNDERPLATE: NICKEL.  
LATERAL FOOT BRUSH GOLD
- MULTIMEDIA CARD COMPATIBLE

PART NO. INFORMATION

**TFWF - 09 X X 5 R - 009**

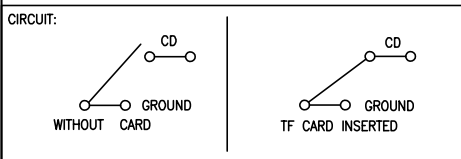
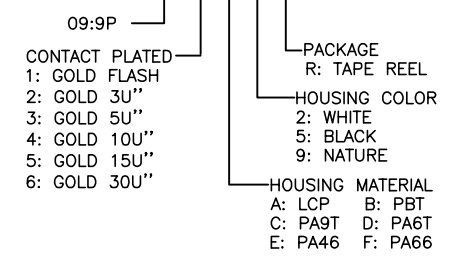

NO.	ASSIGNMENT	NO.	ASSIGNMENT
1#	DAT2	5#	CLK
2#	CD/DAT3 <sup>2</sup>	6#	VSS
3#	CMD	7#	DAT0
4#	VDD	8#	DAT1

**Bestcreate Technology Limited**

TOLERANCES UNLESS OTHERWISE SPECIFIED:

.X ± 0.35	X.* ± 5'
.XX ± 0.25	.X.* ± 2'
.XXX ± 0.15	.XX.* ± 1'

Website: www.bsc-elec.com  
Email: bestcreate@bsc-elec.com

DESIGN: I.L	DATE: 2017.3.1
CHECKED: C.W	DATE: 2017.3.1
APPROVED: C.W	DATE: 2017.3.1

TITLE: PUSH T-FLASH CARD 1.85H 外焊 短平齐型CONN		
MATERIAL: FINISH:	PART NO: TFWF-09XX5R-009 DWG NO: TFWF-09XX5R-009	SIZE: A4 SHEET: 1 OF 2

REV: A	UNIT: mm	SCALE: 1=1	QUALITY SYMBOLS:
--------	----------	------------	------------------

RoHS Compliant

REVISIONS			
REV.	DESCRIPTION	DATE	DESIGN

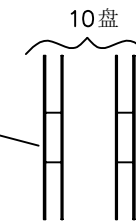
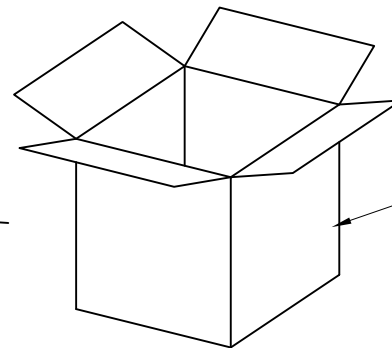
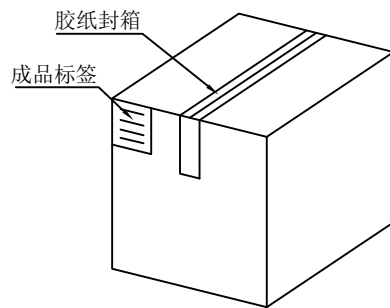
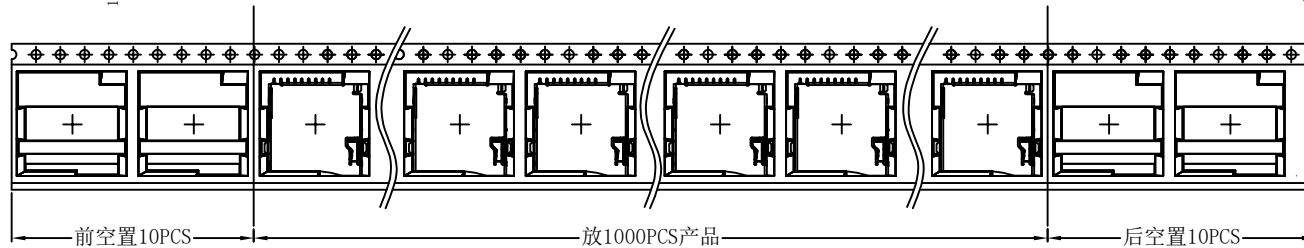
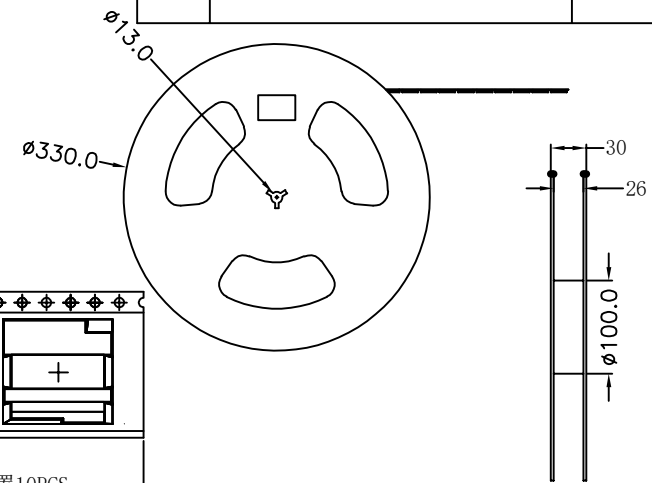
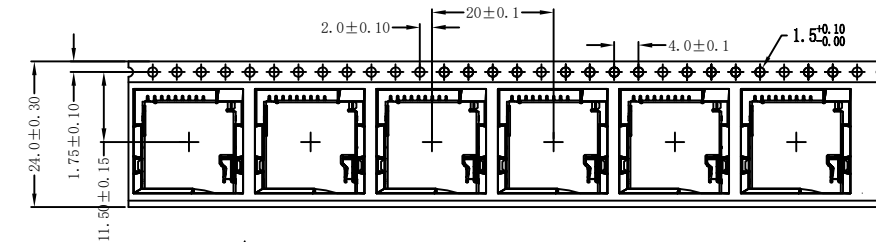

纸箱规格: 345\*345\*310

包装方式:

- 1 将卷带放入包装机后, 前空10PCS, 后放产品1000PCS, 再后空10PCS;
- 2 将包装好的产品从包装机上取下, 用美纹胶纸封口, 再使用封口透明带缠绕其一圈后用美纹胶纸封口;
- 3 把累叠好的10盘叠放入纸箱中共计10Kset;
- 4 把包装好的成品打包封箱, 并在纸箱外贴上标签

**Bestcreate Technology Limited**

TOLERANCES UNLESS OTHERWISE SPECIFIED:

.X	±	0.35	X.*	±	5*
.XX	±	0.25	.X*	±	2*
.XXX	±	0.15	.XX*	±	1*

Website: www.bsc-elec.com  
Email: bestcreate@bsc-elec.com

DESIGN: I.L  
DATE: 2017.3.1

CHECKED: C.W  
DATE: 2017.3.1

APPROVED: C.W  
DATE: 2017.3.1

TITLE: PUSH T-FLASH CARD  
1.85H 外焊 短平齐型CONN

MATERILA:	PART NO: TFWF-09XX5R-009	SIZE: A4
FINSH:	DWG NO: TFWF-09XX5R-009	SHEET: 2 OF 2

REV: A	UNIT mm	SCALE 1=1	QUALITY SYMBOLS
--------	---------	-----------	-----------------