

RoHS Compliant

REVISIONS			
REV.	DESCRIPTION	DATE	DESIGN

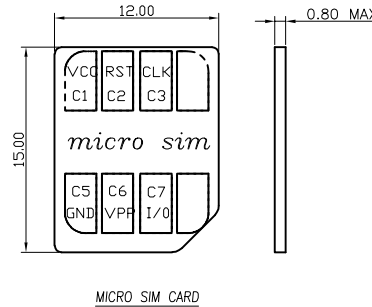
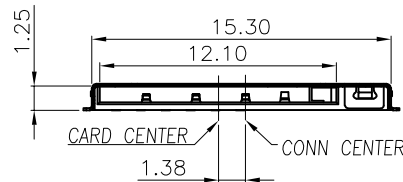
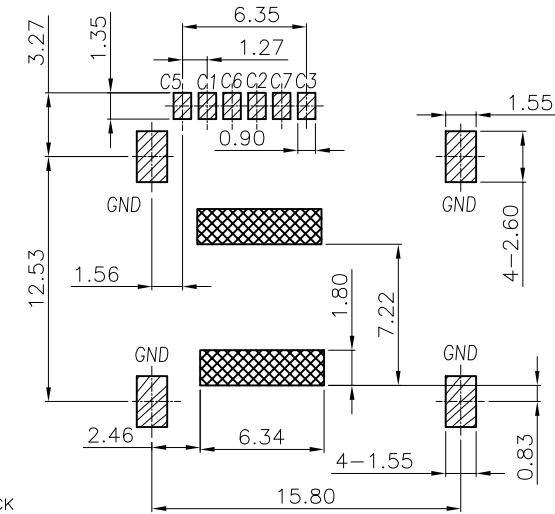
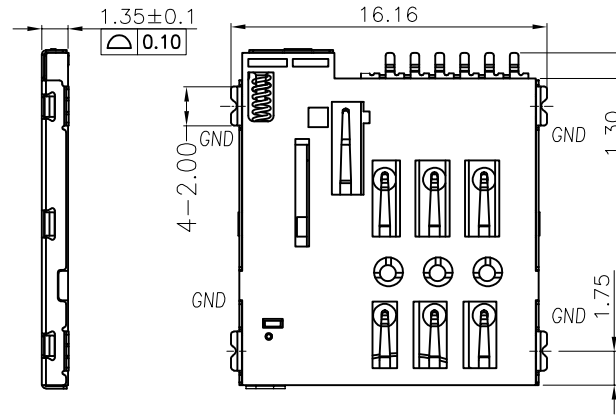
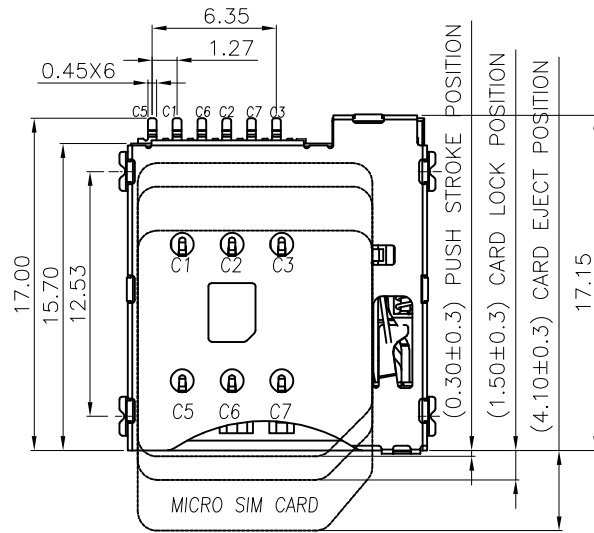

- MATERIAL:
  - HOUSING:LCP,UL94-V0,COLOR:BLACK
  - CONTACT:C5210R-H
  - SHELL:SUS304-H
- FINISH:
  - TERMINAL:30 u" Min.NICKEL PLATED OVERALL
  - CONTACT:GOLD FLASH PLATED ON CONTACT AREA; GOLD FLASH PLATED ON SOLDER TAILS;
- ELECTRICAL CHARACTERISTICS
 

RATING CURRENT : 0.5A MAX.  
 CONTACT RESISTANCE :50 mΩ MAX  
 DIELECTRIC WITHSTANDING : 500V AC MIN.  
 INSULATION RESISTANCE: 1000 MΩ MIN.
- MECHANICAL CHARACTERISTICS
 

MATING CYCLE :3000 CYCLES  
 Contact retention force: 50gf/pin Min.
- PART NO.

**FORBIDDEN AREA**  
**SMT SOLDER AREA**  
 THERE SHOULD NOT BE ANY CIRCUITRIES IN THE LAYOUT SPACE OF THE PRODUCTS.  
RECOMMENDED PCB LAYOUT  
 GENERAL TOLERANCE ±0.05

**MCSIM -06 X X 5 R - 010**

- 06:06P
- CONTACT PLATED
  - GOLD FLASH
  - GOLD 3U"
  - GOLD 5U"
  - GOLD 10U"
  - GOLD 15U"
  - GOLD 30U"
- PACKAGE
  - TAPE REEL
- HOUSING COLOR
  - WHITE
  - BLACK
  - NATURE
- HOUSING MATERIAL
  - LCP
  - PBT
  - PA9T
  - PA6T
  - PA46
  - PA66

SIM pin Assignment	
PIN#	Name
C1	VCC
C2	RST
C3	CLK
C5	GND
C6	VPP
C7	I/O

**Bestcreate Technology Limited**

TOLERANCES UNLESS OTHERWISE SPECIFIED:			
.X	±	0.35	X.* ± 5'
.XX	±	0.25	.X.* ± 2'
.XXX	±	0.15	.XX.* ± 1'

Website:www.bsc-elec.com  
 Email:bestcreate@bsc-elec.com

DESIGN:	DATE:
I.L	2017.3.1
CHECKED:	DATE:
C.W	2017.3.1
APPROVED:	DATE:
C.W	2017.3.1

TITLE: MICRO SIM CARD PUSH PUSH 6PIN 1.35H		
MATERILA:	PART NO:	SIZE:
FINSH:	MCSIM-06XX5R-010	A4
	MCSIM-06XX5R-010	SHEET: 1 OF 2

REV: A	UNIT mm	SCALE 1=1	QUALITY SYMBOLS
--------	---------	-----------	-----------------

RoHS Compliant

REVISIONS			
REV.	DESCRIPTION	DATE	DESIGN

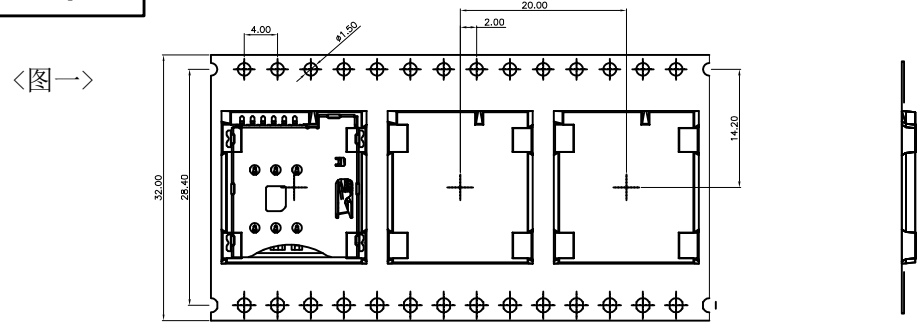

<图一>

<图三>

<TABLE 1> PACKAGING QUANTITY

QTY/REEL	REEL/CARTON	QTY/CARTON
1200	9	10800

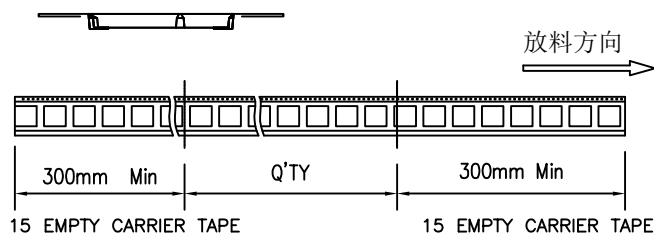
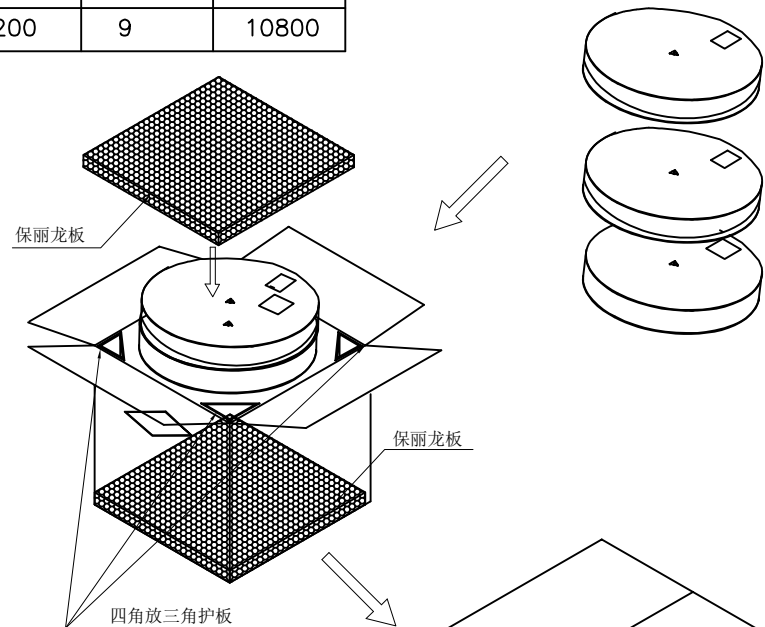

<图二>

COVER TAPE PEELING FORCE: 50gf~150gf

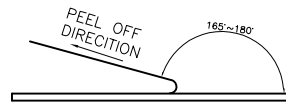

NOTE:

1. 依<图一>示放置产品于下载中, 每穴放置1PCS产品.
2. 包装机包好后, 在REEL的个等分点上贴胶布, 以防止REEL张开, 每REEL贴1PCS标签, 如<图二>示
3. 包装数量见如<TABLE 1>示
4. 包装成箱见如<图三>示  
箱底放保丽龙板, 再依次将指定数量的卷装产品放入箱内, 四角分别放入四个三角护板, 最上层再放上保丽龙板.
5. 封箱, 在封好的纸箱上按客户要求写上料号, 数量等

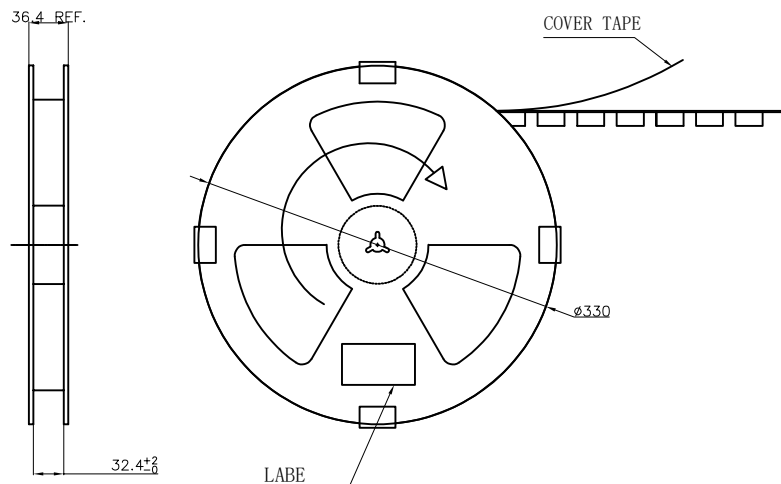

**Bestcreate Technology Limited**

TOLERANCES UNLESS OTHERWISE SPECIFIED:

.X	± 0.35	X.*	± 5*
.XX	± 0.25	.X*	± 2*
.XXX	± 0.15	.XX*	± 1*

Website: www.bsc-elec.com  
Email: bestcreate@bsc-elec.com

DESIGN: I.L DATE: 2017. 3. 1

CHECKED: C.W DATE: 2017. 3. 1

APPROVED: C.W DATE: 2017. 3. 1

TITLE: MICRO SIM CARD PUSH PUSH  
6PIN 1.35H 包装规范

MATERILA:	PART NO: MCSIM-06XX5R-010	SIZE: A4
FINSH:	DWG NO: MCSIM-06XX5R-010	SHEET: 2 OF 2

REV: A	UNIT: mm	SCALE: 1=1	QUALITY SYMBOLS:
--------	----------	------------	------------------