

RoHS Compliant

REVISIONS

REV.	DESCRIPTION	DATE	DESIGN

NOTES:

1. MATERIAL:

- 1.1 HOUSING:SEE TABLE ORDERING INFORMATION
- 1.2 CONTACTS:Copper Alloy(C7025)
- 1.3 SHELL:**Stainless steel**

2. ELECTRICAL CHARACTERISTICS:

- 2.1 CONTACTRESISTANCE:40mΩ Max FOR INTIAL.10mΩ CHANGE AFTER TEST. MEASURE at 20mv, 100mA.
- 2.2 CONTACT CURRENT RATING:3A FOR VBUS PIN;1.25A FOR VCONN and GND PIN;0.25A FOR all THE OTHER PIN.
- 2.3 CLTAGE RATING:30V
- 2.4 DIELECTRIC WITHSTANDING VOLTAGE:100 V R.M.S.
- 2.5 INSULATION RESISTANCE 100 MEGOHMS MIN

3. MECHANICAL PERFORMANCE:

- 3.1 INSERT FORCE:0.51-2.04Kg
- 3.2 EXTRACT FORCE:0.82-2.04Kg
- 3.3 AFTER DURABILITY:0.61-2.04Kg
- 3.4 DURABILITY:5000 CYCLES

4. ENVIRONMENTAL:

- 4.1 OPERATION TEMPERATURE: -20℃ to +85℃

PART NO. INFORMATION

U06-C F X X 5 R - W032

PORT TYPE C: TYPE C	PACKAGE R: TAPE REEL
GENDER F: FEMALE M: MALE	HOUSING COLOR 2: WHITE 5: BLACK 9: NATURE
CONTACT PLATED 1: GOLD FLASH 2: GOLD 3U" 3: GOLD 5U" 4: GOLD 10U" 5: GOLD 15U" 6: GOLD 30U"	HOUSING MATERIAL A: LCP B: PBT C: PA9T D: PA6T E: PA46 F: PA66

A

B

C

D

A

B

C

D

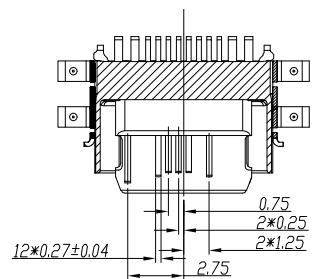
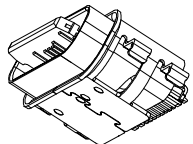
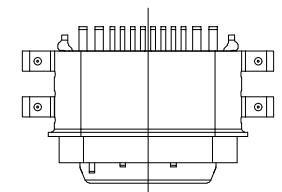

SEC B-B

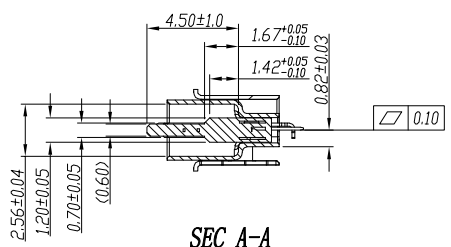
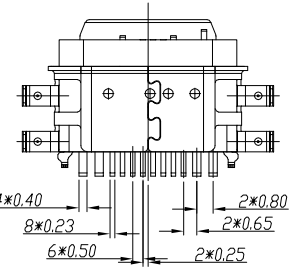
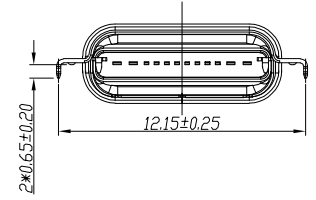
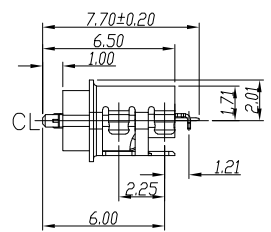
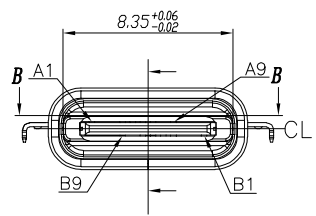

SEC A-A

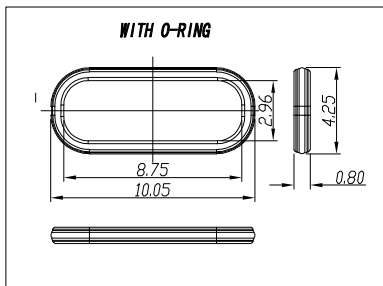
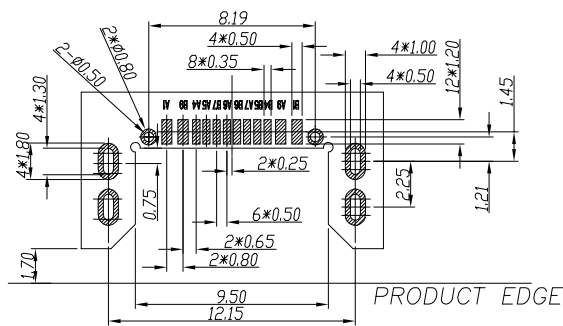

PRODUCT NO.	ITEM	PART NAME	PART NO.	Q'TY	MATERIAL
SNF10T010R-W	6	防水胶圈		1PCS	硅胶 黑色
	5	中间片		1PCS	SUS304-1/2H T=0.15mm
	4	护套壳子		1PCS	SUS304-1/2H T=0.2mm 镀镍, 盐雾48H
	3	MOLDING端子		2PCS	LCP/C7025 半金雾锡1U"
	2	端子		2PCS	C7025 T=0.15mm 半金镍1U"
	1	拉伸壳子		1PCS	SUS316L T=0.2mm 镀镍

ALL MATERIAL MEET THE FORMAN'S SPEC: ENVIRONMENT-RELATED SUBSTANCES MANAGEMENT TECHNICAL STANDARD

Bestcreate Technology Limited

TOLERANCES UNLESS OTHERWISE SPECIFIED:

.X	± 0.20	X.'	± 5'
.XX	± 0.15	.X.'	± 2'
.XXX	± 0.10	.XX.'	± 1'

Website:www.bsc-elec.com
Email:bestcreate@bsc-elec.com

DESIGN: I. L	DATE:
CHECKED: C. W	DATE:
APPROVED: C. W	DATE:

TITLE: IPX7 Waterproof USB TYPE C 12P FEMALE CONNECTOR		
MATERILA:	PART NO: U06-CFXX5R-W032	SIZE: A4
FINSH:	DWG NO: U06-CFXX5R-W032	

REV: A	UNIT mm	SCALE 1=1	QUALITY SYMBOLS
-----------	------------	--------------	-----------------