

RoHS Compliant

REVISIONS			
REV.	DESCRIPTION	DATE	DESIGN

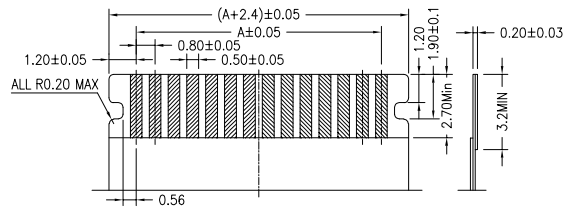

Applicable FPC

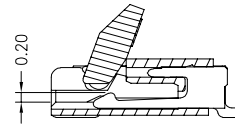
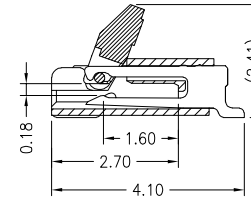
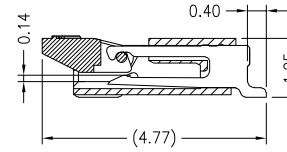
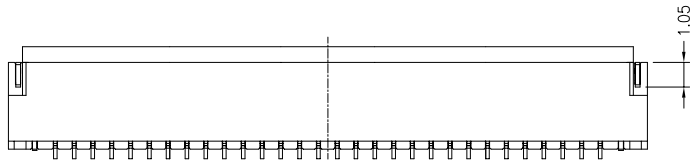
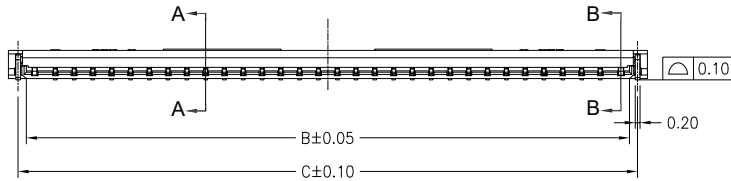
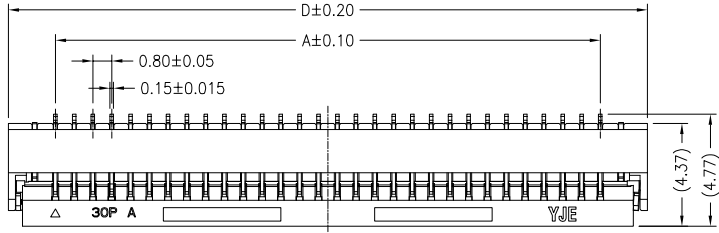
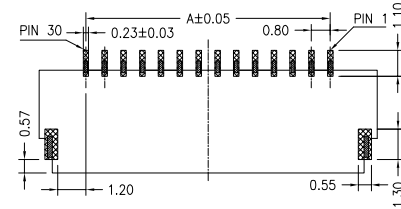

RECOMMEND PCB LAYOUT
Tolerance: ±0.05

NOTES:

1.MATERIAL:

- 1.1 HOUSING:THERMOPLASTIC,HIGH TEMP,UL94V-0.
- 1.2 ACTUATOR:THERMOPLASTIC,HIGH TEMP,UL94V-0.
- 1.3 CONTACT:COPPER ALLOY.
- 1.4 FITTING NAIL:COPPER ALLOY.

2.FINISH:

- 2.1 CONTACT AREA:
NICKEL LOW 50u"CONTACT AREA GILT THICKNESS ACCORDING TO MATERIAL NUMBER
- 2.2 SOLDER AREA:
COLD FLASH ON SOLDER AREA:
50~100u"NICKEL UNDER PLATING OVER ALL.
- 2.3 FITTING NAIL;
100~200u"MATT TIN PLATING ON SOLDER TAILS
50~100u"NICKEL UNDER PLATING OVER ALL.

3.MATERIAL NO.

FPC0812X-XXXRK-XXXXR

- A:No marks
 - A1: GOLD FLASH ON CONTACT
 - A3: 3u"GOLD ON CONTACT
 - N: ACTUATOR NATURAL
 - B: ACTUATOR BLACK
 - N: HOUSING NATURAL
 - B: HOUSING BLACK
- 022: 22Pin
032: 32Pin

CKT	A	B	C	D
22	16.80	19.27	19.97	20.80
23	17.60	20.07	20.77	21.60
24	18.40	20.87	21.57	22.40
25	19.20	21.67	22.37	23.20
26	20.00	22.47	23.17	24.00
27	20.80	23.27	23.97	24.80
28	21.60	24.07	24.77	25.60
29	22.40	24.87	25.57	26.40
30	23.20	25.67	26.37	27.20
31	24.00	26.47	27.17	28.00
32	24.80	27.27	27.97	28.80

Bestcreate Technology Limited

TOLERANCES UNLESS OTHERWISE SPECIFIED:

.X	± 0.25	.X'	± 3'
.XX	± 0.20	.X''	± 2'
.XXX	± 0.15	.XXX'	± 1'

Website:www.bsc-elec.com
Email:bestcreate@bsc-elec.com

DESIGN: I.L
DATE: 2017.3.1

CHECKED: C.W
DATE: 2017.3.1

APPROVED: C.W
DATE: 2017.3.1

TITLE: FPC 0.8 PITCH EASY ON
TYPE H=1.2mm LOCK

MATERILA: FPC0812A-030RK-XXA1R
PART NO: FPC0812A-030RK-XXA1R
SIZE: A4

FINSH: FPC0812A-030RK-XXA1R
DWG NO: FPC0812A-030RK-XXA1R
SHEE: 1 OF 2

REV: A
UNIT: mm
SCALE: 1=1
QUALITY SYMBOLS:

RoHS Compliant

REVISIONS			
REV.	DESCRIPTION	DATE	DESIGN

Note:

- 1.10 sprocket hole pitch cumulative tolerance ± 0.2
2. Carrier camber is within 1 mm in 250mm.
3. Material: Black Conductive Polystyrene Alloy 100% recyclable.
4. All dimensions meet EIA-481-B requirements.
5. Thickness: 0.30 ± 0.05 mm.
6. Component load per 13" reel: 3000 pcs.
7. The following specifications are shown in the table below
8. Carton Size: 350x350x340mm

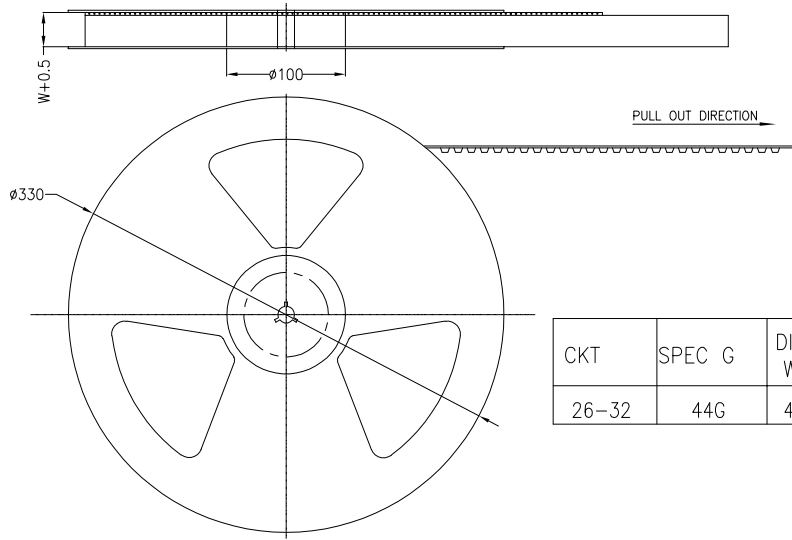

CKT	SPEC G	DIM. W	DIM. F	DIM. So	rell/carton
26-32	44G	44.0	20.2	40.4	6

PULL OUT DIRECTION

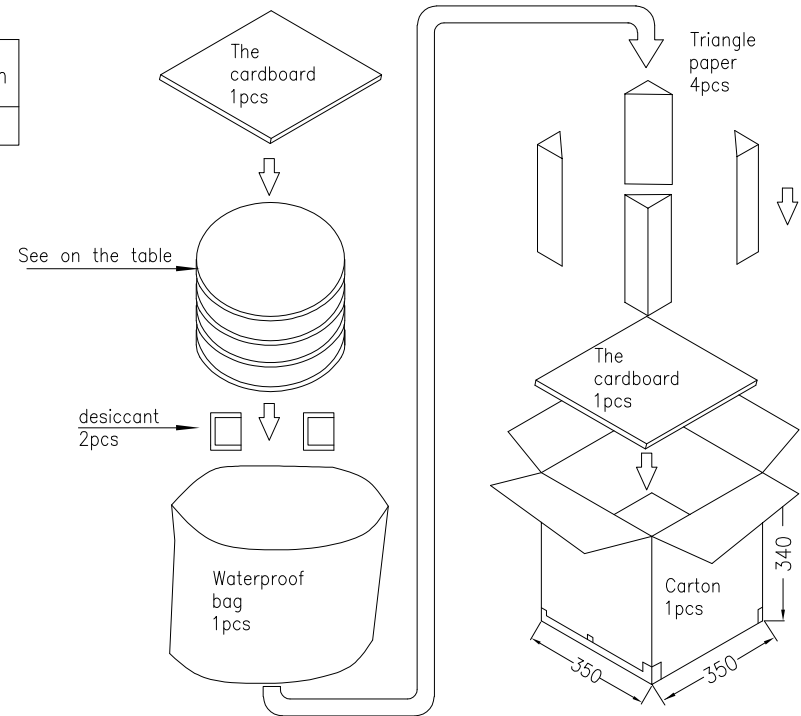
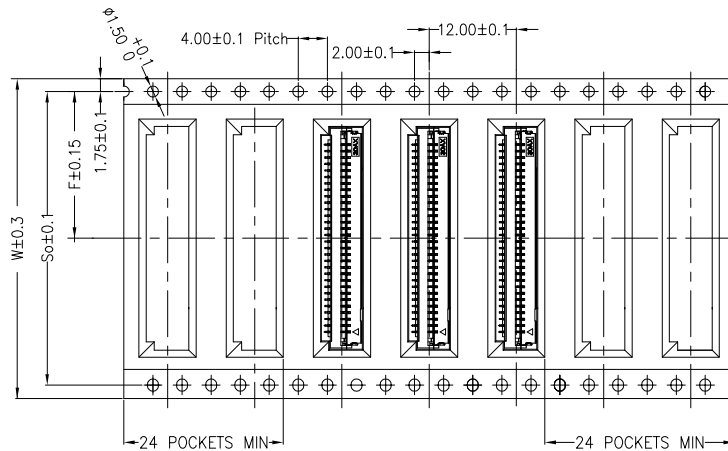

Bestcreate Technology Limited

TOLERANCES UNLESS OTHERWISE SPECIFIED:

.X	± 0.25	.X'	± 3'
.XX	± 0.20	.X''	± 2'
.XXX	± 0.15	.XX''	± 1'

Website: www.bsc-elec.com
Email: bestcreate@bsc-elec.com

DESIGN: I. L
DATE: 2017. 3. 1

CHECKED: C. W
DATE: 2017. 3. 1

APPROVED: C. W
DATE: 2017. 3. 1

TITLE: FPC 0.8 PITCH EASY ON
TYPE H=1.2mm LOCK

MATERIAL: FPC0812A-030RK-XXA1R
PART NO: FPC0812A-030RK-XXA1R
SIZE: A4

FINISH: FPC0812A-030RK-XXA1R
DWG NO: FPC0812A-030RK-XXA1R
SHEET: 2 OF 2

REV: A
UNIT: mm
SCALE: 1=1
QUALITY SYMBOLS: