

RoHS Compliant

| REVISIONS | | | |
|-----------|-------------|------|--------|
| REV. | DESCRIPTION | DATE | DESIGN |
| | | | |

1.MATERIAL
 HOUSING:LCP UL 94V-0
 ACTUATOR:LCP UL 94V-0
 CONTACTS:COPPER ALLOY
 PEG: COPPER ALLOY
 2.PLATING:
 CONTACTS:GOLD FLASH OVER NICKEL
 PEG:TIN OVER NICKEL
 3.PART NO:
 OPERATING VOLTAGE:50V AC,DC
 CURRENT RATING:0.5A AC,DC
 OPERATING TEMPERATURE:-25C~+85C

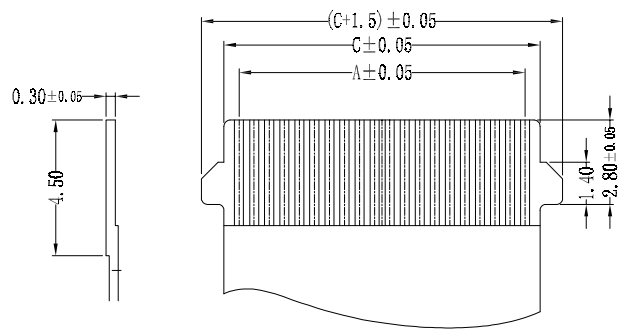
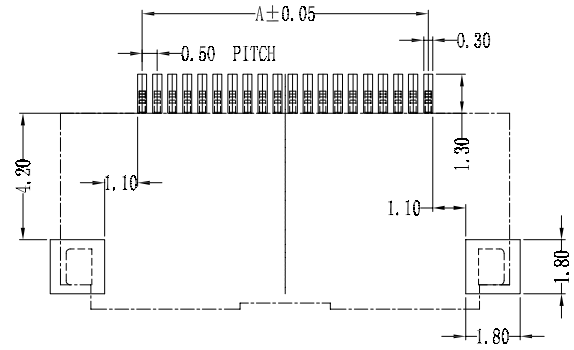
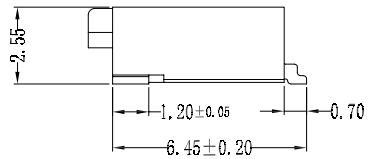
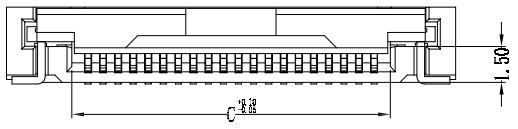
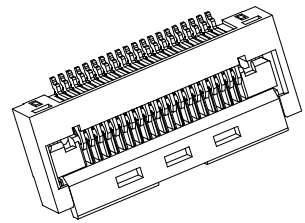
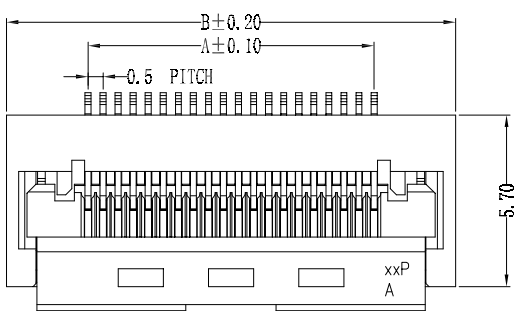

| No. of Contacts | DIM. | | |
|-----------------|-------|-------|-------|
| | A | B | C |
| 08 | 3.50 | 8.92 | 4.50 |
| 09 | 4.00 | 9.42 | 5.00 |
| 10 | 4.50 | 9.92 | 5.50 |
| 20 | 9.50 | 14.92 | 10.50 |
| 24 | 11.50 | 16.92 | 12.50 |
| 25 | 12.00 | 17.42 | 13.00 |
| 28 | 13.50 | 18.92 | 14.50 |
| 30 | 14.50 | 19.92 | 15.50 |
| 40 | 19.50 | 24.92 | 20.50 |
| 50 | 24.50 | 29.92 | 25.50 |
| 60 | 29.50 | 34.92 | 30.50 |

PART NO. INFORMATION

FPC05-XX 0 1 X - B014

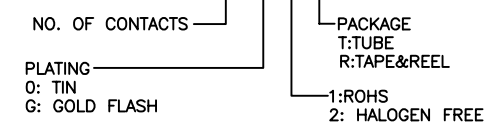

Bestcreate Technology Limited

TOLERANCES UNLESS OTHERWISE SPECIFIED:

| | | | |
|-----|--------|------|--------|
| X. | ± 0.30 | X.' | ± 2' |
| .X | ± 0.25 | .X' | ± 1' |
| .XX | ± 0.10 | .XX' | ± 0.5' |

Website:www.bsc-elec.com
 Email:bestcreate@bsc-elec.com

| | | | |
|-----------|------|-------|------------|
| DESIGN: | I. L | DATE: | 2017. 3. 1 |
| CHECKED: | C. W | DATE: | 2017. 3. 1 |
| APPROVED: | C. W | DATE: | 2017. 3. 1 |

| | | |
|--|------------------------------|----------|
| TITLE: 0.5MM FPC CONNECTOR SMT TYPE 2.5H | | |
| MATERIALA: | PART NO: FPC05-XXX1X-B014 | SIZE: A4 |
| FINSH: | DWG NO: FPC05-XXX1X-B014 | 1 OF 2 |

| | | | |
|--------|---------|-----------|-----------------|
| REV: A | UNIT mm | SCALE 1=1 | QUALITY SYMBOLS |
|--------|---------|-----------|-----------------|