

RoHS Compliant

REVISIONS			
REV.	DESCRIPTION	DATE	DESIGN

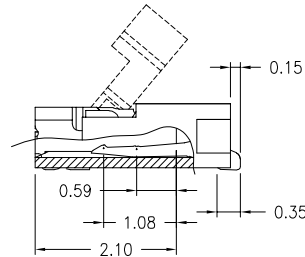

Section X-X
scale2: 1

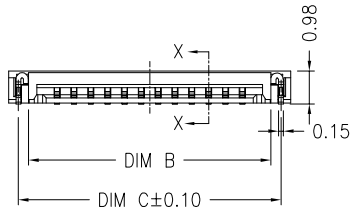
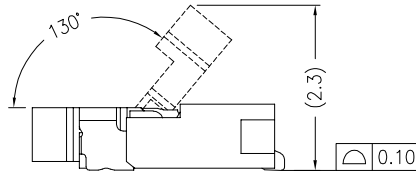
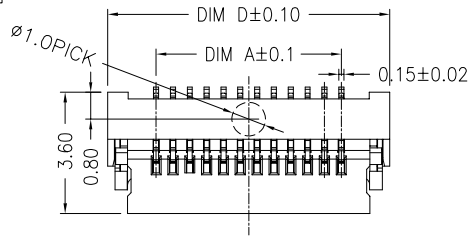
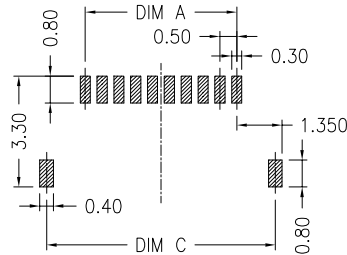
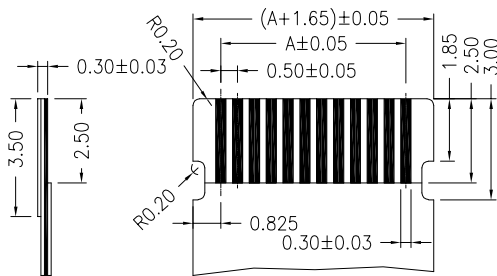
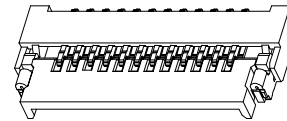
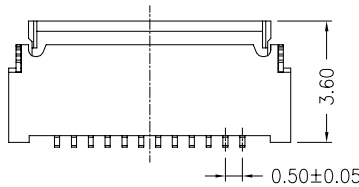

RECOMMEND PCB LAYOUT
Tolerance: ±0.05

Accommodated FFC/FPC

NOTES:

- MATERIAL:
 - HOUSING: THERMOPLASTIC, HIGH TEMP., UL94V-0. COLOR IS WHITE
 - ACTUATOR: THERMOPLASTIC, HIGH TEMP., UL94V-0. COLOR IS BLACK
 - CONTACT: COPPER ALLOY
 - FITTING NAIL: COPPER ALLOY
- FINISH:
 - CONTACT AREA: ACCORDING TO THE REQUIREMENTS 50~100u" NICKEL UNDER PLATING OVER ALL.
 - SOLDER AREA: GOLD FLASH ON SOLDER AREA. 50~100u" NICKEL UNDER PLATING OVER ALL.
 - FITTING NAIL: 100~200u" MATT TIN PLATING ON SOLDER TAILS(LEAD FREE) 50~100u" NICKEL UNDER PLATING OVER ALL.
- REFLOW SOLDER CAPABLE TO 260°C
- PART NUMBER FPC0510A-XXXRK-NBXXR

004: 4Pin
050: 50Pin

A1=Au:G/F
A3=Au:3u"

CKT	A	B	C	D	CKT	A	B	C	D
4	1.50	3.20	3.80	4.37	28	13.50	15.20	15.80	16.37
5	2.00	3.70	4.30	4.87	29	14.00	15.70	16.30	16.87
6	2.50	4.20	4.80	5.37	30	14.50	16.20	16.80	17.37
7	3.00	4.70	5.30	5.87	31	15.00	16.70	17.30	17.87
8	3.50	5.20	5.80	6.37	32	15.50	17.20	17.80	18.37
9	4.00	5.70	6.30	6.87	33	16.00	17.70	18.30	18.87
10	4.50	6.20	6.80	7.37	34	16.50	18.20	18.80	19.37
11	5.00	6.70	7.30	7.87	35	17.00	18.70	19.30	19.87
12	5.50	7.20	7.80	8.37	36	17.50	19.20	19.80	20.37
13	6.00	7.70	8.30	8.87	37	18.00	19.70	20.30	20.87
14	6.50	8.20	8.80	9.37	38	18.50	20.20	20.80	21.37
15	7.00	8.70	9.30	9.87	39	19.00	20.70	21.30	21.87
16	7.50	9.20	9.80	10.37	40	19.50	21.20	21.80	22.37
17	8.00	9.70	10.30	10.87	41	20.00	21.70	22.30	22.87
18	8.50	10.20	10.80	11.37	42	20.50	22.20	22.80	23.37
19	9.00	10.70	11.30	11.87	43	21.00	22.70	23.30	23.87
20	9.50	11.20	11.80	12.37	44	21.50	23.20	23.80	24.37
21	10.00	11.70	12.30	12.87	45	22.00	23.70	24.30	24.87
22	10.50	12.20	12.80	13.37	46	22.50	24.20	24.80	25.37
23	11.00	12.70	13.30	13.87	47	23.00	24.70	25.30	25.87
24	11.50	13.20	13.80	14.37	48	23.50	25.20	25.80	26.37
25	12.00	13.70	14.30	14.87	49	24.00	25.70	26.30	26.87
26	12.50	14.20	14.80	15.37	50	24.50	26.20	26.80	27.37
27	13.00	14.70	15.30	15.87					

Bestcreate Technology Limited

TOLERANCES UNLESS OTHERWISE SPECIFIED:

.X	± 0.25	.X'	± 3'
.XX	± 0.20	.X'	± 2'
.XXX	± 0.15	.XX'	± 1'

DESIGN: DATE:

I. L 2017. 3. 1

CHECKED: DATE:

C. W 2017. 3. 1

APPROVED: DATE:

C. W 2017. 3. 1

TITLE: **0.5Pitch H=1.0FPC Easy-on R/A Typel SMT CONN**

MATERIAL: PART NO: FPC0510A-XXXRK-NBXXR SIZE: A4

FINISH: DWG NO: FPC0510A-XXXRK-NBXXR

Website: www.bsc-elec.com
Email: bestcreate@bsc-elec.com

REV: A UNIT mm SCALE 1=1 QUALITY SYMBOLS

RoHS Compliant

REVISIONS			
REV.	DESCRIPTION	DATE	DESIGN

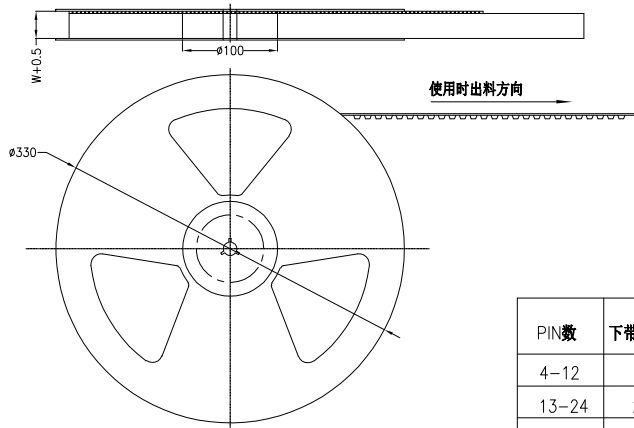

PIN数	下带规格 G	DIM. W	DIM. F	DIM. So	卷/纸箱
4-12	16G	16.0	7.5	—	15
13-24	24G	24.0	11.5	—	10
30-39	32G	32.0	14.2	28.4	8
40-50	44G	44.0	14.2	40.4	6

NOTE:

- 1.10 Sprocket hole pitch cumulative tolerance ± 0.20 .
2. Carrier camber is within 1mm in 100mm.
3. Material Thickness: 0.3 ± 0.05 mm.
4. All dimensions meet EIA-481-B requirements.
5. 3000pcs Pef Reel.
6. For tape width(dim W)16 and 24mm pilot holes are provided on one sides. For tape width(dim W)32, 44 and 56mm pilot holes are provided on both sides.

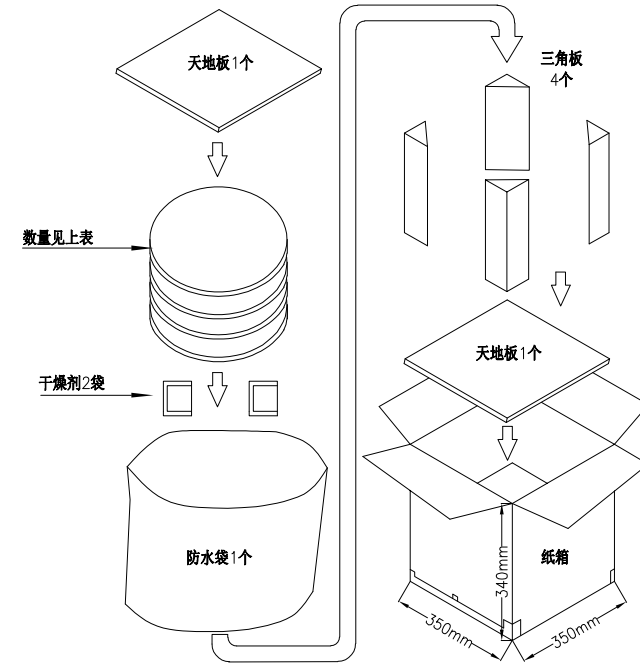
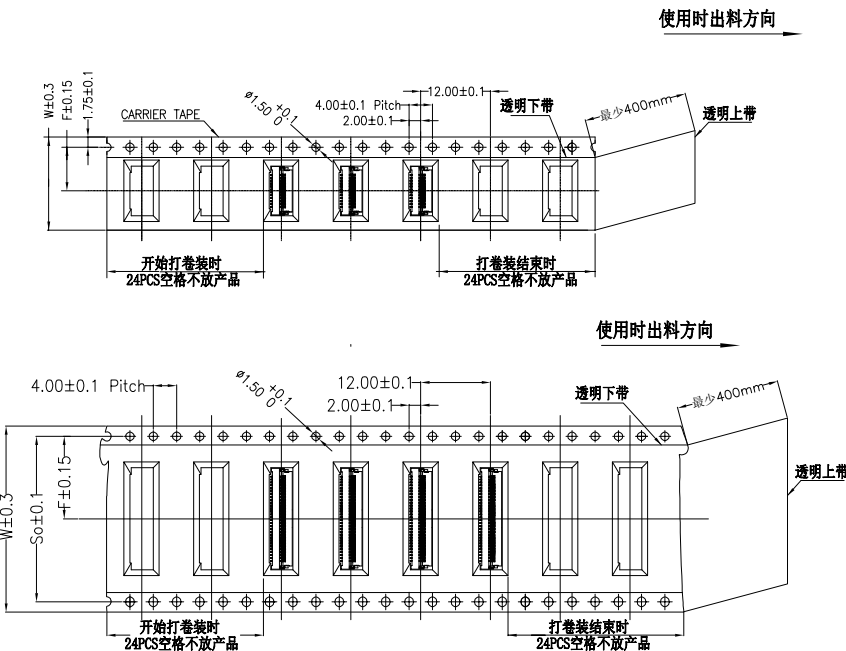

Bestcreate Technology Limited

TOLERANCES UNLESS OTHERWISE SPECIFIED:

.X	± 0.25	.X*	± 3*
.XX	± 0.20	.X*	± 2*
.XXX	± 0.15	.XX*	± 1*

Website: www.bsc-elec.com
Email: bestcreate@bsc-elec.com

DESIGN: I. L
DATE: 2017. 3. 1

CHECKED: C. W
DATE: 2017. 3. 1

APPROVED: C. W
DATE: 2017. 3. 1

TITLE: **0.5Pitch H=1.0FPC Easy-on R/A Type1 SMT CONN**

MATERIAL: PART NO: FPC0510A-XXXRK-NBXXR

FINISH: DWG NO: FPC0510A-XXXRK-NBXXR

SIZE: A4

REV: A
UNIT: mm
SCALE: 1=1
QUALITY SYMBOLS: