

RoHS Compliant

REVISIONS			
REV.	DESCRIPTION	DATE	DESIGN

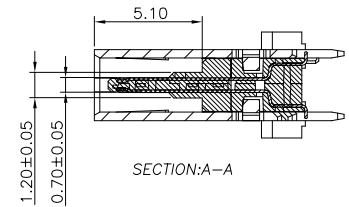
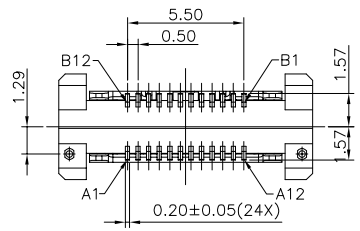
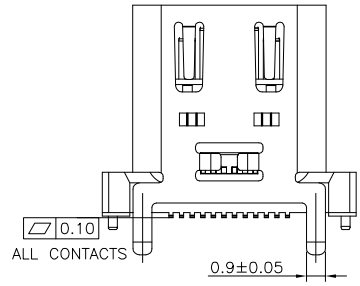
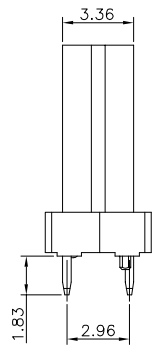
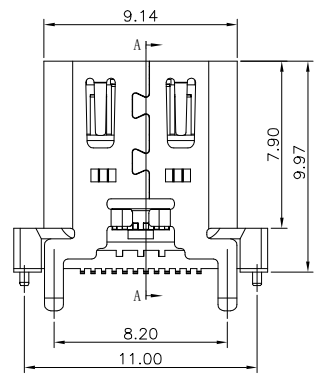
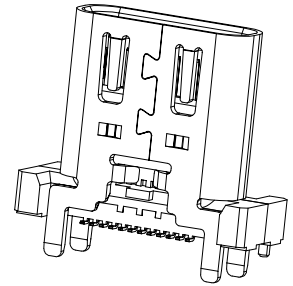
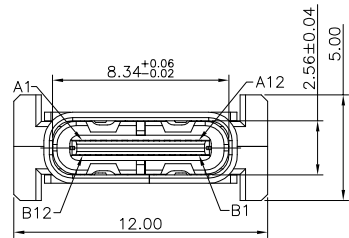

NOTE:
 1.MATERIAL SPECIFICATION:
 1.HOUSING:LCP,UL94 V-0.
 2.TERMINAL: COPPER ALLOY(C1814)
 3.MID PLATE: STAINLESS STEEL(SUS301)
 4.FRONT SHELL: STAINLESS STEEL(SUS304)
 2.PLATING SPECIFICATION:
 2-1.TERMINAL:
 Ni 50u" MIN. UNDER PLATED OVER ALL.
 Au PLATED ON THE FUNCTIONAL AREA OF CONTACT.
 (GOLD PLATING THICKNESS FOLLOW THE P/N)
 PLATING SPECIFICATIONS OF THE SOLDER AREA FOLLOW THE P/N
 2-2.SHELL:
 Ni 50u" MIN. UNDER PLATED OVER ALL.
 2-3.MID PLATE:
 CLEAR ONLY
 3.MECHANICAL PERFORMANCE,
 3-1.INSERTION FORCE: 0.5~2.0kgf.
 3-2.REMOVAL FORCE: 0.8kgf~2.0kgf.
 3-3.DURABILITY: 10000 CYCLES.
 4.ELECTRICAL PERFORMANCE,
 4-1. VOLTAGE RATING:5 V DC/AC (RMS. max)
 CURRENT RATING:5 AMPS. FOR TOTAL VBUS/GND PINS;
 1.25AMPS FOR CC PIN,0.25 AMPS. FOR ALL OTHER CONTACT.
 4-2. LLCR:
 VBUS & GND PINS AND OTHER PINS: 40mΩ/PIN MAX.
 SHIELD: 50mΩ/MAX.
 LLCR MAX. CHANGE OF ALL PINS: 10mΩ.
 4-3.INSULATION RESISTANCE: 100MΩ MIN
 4-4.DIELECTRIC WITHSTAND VOLTAGE,AC 100V FOR 1 MINUTE.
 5. ENVIRONMENTAL PERFORMANCE:
 OPERATING TEMPERATURE: -25°C~+85°C.
 6.IR REFLOW:
 THE PEAK TEMPERATURE ON THE BOARD SHALL
 BE MAINTAINED FOR 10 SECONDS AT 260°C.

PART NO. INFORMATION

U06-C F X X 5 R - 051

PORT TYPE
 C: TYPE C
 PACKAGE
 R: TAPE REEL
 HOUSING COLOR
 2: WHITE
 5: BLACK
 9: NATURE
 HOUSING MATERIAL
 A: LCP B: PBT
 C: PA9T D: PA6T
 E: PA46 F: PA66
 CONTACT PLATED
 1: GOLD FLASH
 2: GOLD 3U"
 3: GOLD 5U"
 4: GOLD 10U"
 5: GOLD 15U"
 6: GOLD 30U"
 GENDER
 F: FEMALE
 M: MALE

Bestcreate Technology Limited

TOLERANCES UNLESS OTHERWISE SPECIFIED:			
X.	± 0.50	X.*	± 5'
.X	± 0.38	.X*	± 2'
.XX	± 0.25	.XX*	± 1'

Website:www.bsc-elec.com
 Email:bestcreate@bsc-elec.com

DESIGN: I.L	DATE:
CHECKED: C.W	DATE:
APPROVED: C.W	DATE:

TITLE: VERTICAL DIP USB 3.1 C FEMALE CONNECTOR		
MATERILA:	PART NO: U06-CFXX5R-051	SIZE: A4
FINSH:	DWG NO: U06-CFXX5R-051	

REV: A	UNIT mm	SCALE 1=1	QUALITY SYMBOLS
-----------	------------	--------------	-----------------

RoHS Compliant

REVISIONS			
REV.	DESCRIPTION	DATE	DESIGN

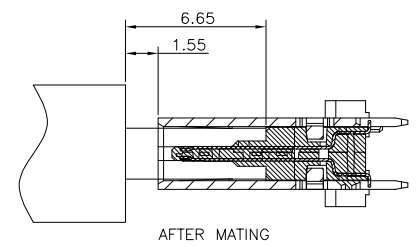
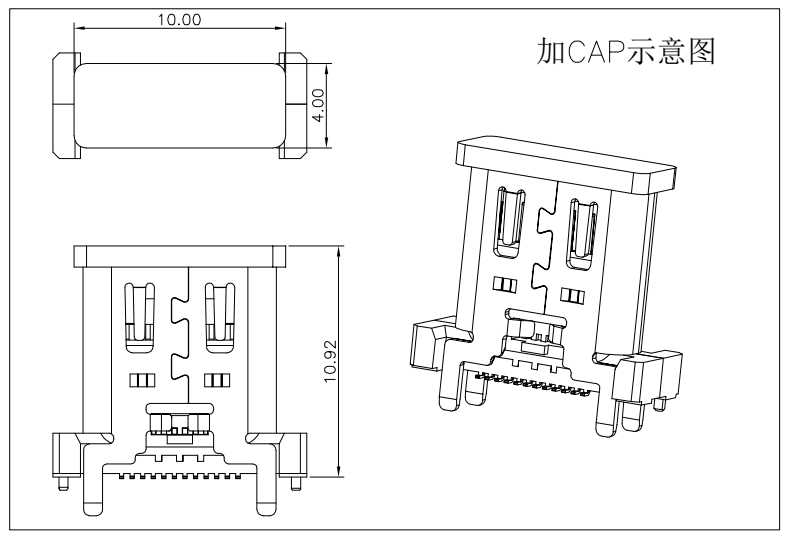

USB TYPE-C PIN ASSIGNMENTS

PIN NUMBER	SIGNAL NAME	PIN NUMBER	SIGNAL NAME
A1	GND	B12	GND
A2	SSTXp1	B11	SSRXp1
A3	SSTXn1	B10	SSRXn1
A4	Vbus	B9	Vbus
A5	CC1	B8	SBU2
A6	Dp1	B7	Dn2
A7	Dn1	B6	Dp2
A8	SBU1	B5	CC2
A9	Vbus	B4	Vbus
A10	SSRXn2	B3	SSTXn2
A11	SSRXp2	B2	SSTXp2
A12	GND	B1	GND

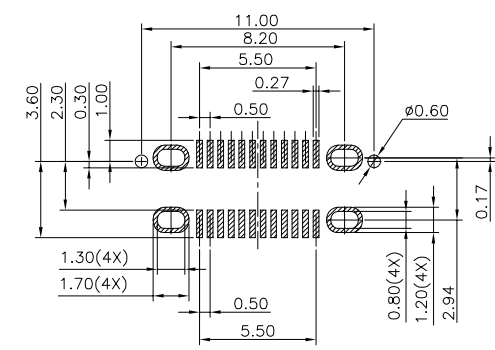

RECOMMENDED PCB LAYOUT(TOP VIEW)
THICKNESS 1.0±0.10MM;DEFAULT TOLERANCE:±0.05

Bestcreate Technology Limited

TOLERANCES UNLESS OTHERWISE SPECIFIED:			
X.	± 0.50	X.*	± 5°
.X	± 0.38	.X*	± 2°
.XX	± 0.25	.XX*	± 1°
Website:www.bsc-elec.com			
Email:bestcreate@bsc-elec.com			

DESIGN: I.L	DATE:
CHECKED: C.W	DATE:
APPROVED: C.W	DATE:

TITLE: USB 3.1 TYPE E KEY A FEMALE CONNECTOR VERTICAL SMT TYPE		
MATERIAL:	PART NO: U06-CFXX5R-051	SIZE: A4
FINISH:	DWG NO: U06-CFXX5R-051	

REV: A	UNIT mm	SCALE 1=1	QUALITY SYMBOLS
-----------	------------	--------------	---------------------